

**DRAFT**  
**1/3/07**

Pacific Gas and Electric Company  
Emerging Technologies Program  
Application Assessment Report \_\_\_\_\_

**Data Center Economizer  
Contamination and Humidity Study**  
Lawrence Berkeley National Laboratory

**Issued:** January 3, 2007

**Project Manager:** Stephen Fok  
Pacific Gas and Electric Company

**Prepared By:** Lawrence Berkeley National Laboratory  
Arman Shehabi  
William Tschudi

# Contents

<b>EXECUTIVE SUMMARY</b>	<b>3</b>
<b>BACKGROUND &amp; OBJECTIVE</b>	<b>4</b>
<b>METHODOLOGY &amp; PROCEDURE</b>	<b>6</b>
<b>FINDINGS</b>	<b>9</b>
<b>DISCUSSION</b>	<b>32</b>
<b>CONCLUSION</b>	<b>36</b>
<b>RECOMMENDATIONS FOR FUTURE WORK</b>	<b>37</b>
<b>REFERENCES</b>	<b>39</b>

## **Executive Summary**

Data centers require continuous air conditioning to address high internal heat loads (heat release from equipment) and maintain indoor temperatures within recommended operating levels for computers. Air economizer cycles, which bring in large amounts of outside air to cool internal loads when weather conditions are favorable, could save substantial cooling energy. There is reluctance from many data center owners to use this common cooling technique, however, due to fear of introducing pollutants and potential loss of humidity control. Concerns about equipment failure from airborne pollutants lead to specifying as little outside air as permissible for human occupants.

To investigate contamination levels, particle monitoring was conducted at eight data centers in Northern California. Particle counters were placed at three to four different locations within and outside of each data center evaluated in this study. Humidity was also monitored at many of the sites to determine how economizers affect humidity control. The results from this study indicate that IT equipment degradation caused by outdoor particles appears to be a poor justification for not using economizers in data centers. Study results are summarized below:

1. The average particle concentrations measured at each location, both outside and at the servers, are shown in Table 1. Measurements show low particle concentrations at all data centers without economizers, regardless of outdoor particle concentrations. Particle concentrations were typically an order of magnitude below both outside particle concentrations and recently published ASHRAE standards.
2. Economizer use caused sharp increases in particle concentrations when the economizer vents were open. The particle concentration in the data centers, however, quickly dropped back to pre-economizer levels when the vents closed. Since economizers only allow outside air part of the time, the annual average concentrations still met the ASHRAE standards.
3. Current filtration in data centers is minimal since most air is typically recycled. When using economizers, modest improvements in filtration can reduce particle concentrations to nearly match the level found in data centers that do not use economizers.
4. Humidity was consistent and within the ASHRAE recommended levels for all data centers without economizers. Results show that, while slightly less steady, humidity in data centers with economizers can also be controlled within the ASHRAE recommended levels.
5. The potential energy savings from economizer use is considerable. Annual savings at one center is estimated within the range of 55-83 MWh/year. Greater savings are available if higher humidity levels in the data center were permitted.

## **Background & Objective**

Data centers require continuous air conditioning to address high internal heat loads (heat release from equipment) and maintain indoor temperatures below the maximum recommended for operating computers. Air economizer cycles, which bring in large amounts of outside air to cool internal loads when weather conditions are favorable, could save substantial cooling energy. There is reluctance from many data center owners to use this common cooling technique however, due to fear of introducing pollutants and potential loss of humidity control. Concerns about equipment failure from airborne pollutants lead to specifying as little outside air as permissible.

ASHRAE's recent publication, "Design Considerations for Data and Communications Equipment Centers," lists possible airborne contaminants and how each could adversely affect electronic data equipment. Some of the contaminants identified by ASHRAE are commonly found in California outdoor air at levels that could be a concern if outside air is directly introduced for cooling data centers. The pollutant of primary concern, when introducing particulate matter to the data center environment, is fine particulate matter that could cause conductor bridging. Outdoor concentrations of fine particulate matter in California are relatively high compared to other areas within the U.S. and can be greater than the indoor limits established by ASHRAE.

Empirical results show that particulate matter composed of deliquescent salts can cause electronic equipment failure. Previous experiments used sulfate salts to demonstrate current leakage from particle deposition under conditions of high humidity (Litvak et al, 2000). While sulfate concentrations are relatively low in California, nitrate salts comprise a large percentage of airborne particle matter in the State. Equipment failure occurs as particles accumulate on electronic equipment and eventually bridge the space between isolated conductors. While the presence of dry particles between conductors is benign, current leakage or shorts can occur if the particle bridge becomes moist. This happens when the relative humidity of the surrounding air rises to a point where the particle will begin to rapidly absorb moisture. This process is called deliquescence and occurs at a relative humidity point specific to the composition of the particle. Under these moist conditions, the water soluble ionic salts in particles can dissociate into cations and anions, and become electrically conductive (Weschler and Shields, 1991). While particle accumulation by deposition between conductors occurs on a timescale of years, the deliquescence of deposited particles can be a rapid event, on the timescale of minutes or seconds. Sudden spikes in relative humidity have the potential to induce equipment failure.

There is limited literature documenting what levels of fine particulate matter affect computer and electronic equipment failures. As a result, there is great variability and little support for the current guidelines regarding acceptable maximum particle concentrations in the operating environment of such equipment.

ASHRAE's Design Considerations for Data and Communications Equipment Centers summarizes recommendations from two different documents (IEC 60721-3-3 and Telcordia GR-63-CORE) which specify concentration limits for particulate matter. The maximum acceptable levels of contaminant specified in these documents are based on studies of equipment failures in telephone switching offices. It is unclear if the guidance for maximum contaminant levels in telephone switching offices translates directly to guidance for data centers. Particulate matter concentration limits suggested by the manufacturers of data center hardware are not as strict as limits summarized by ASHRAE. IBM, for example, publishes particle concentration limits for data processing environments that are three times higher than the limits from Telcordia as summarized in Figure 25 (see discussion - ASHRAE).

ASHRAE's Design Considerations for Data and Communications Equipment Centers recommends relative humidity conditions between 40% and 55%, with an allowable level between 20% and 80%. Particles are believed to require high humidity in order to cause equipment damage. Specifically, the humidity must be above the particle deliquescent point, which indicates the relative humidity at which the particle will begin to absorb water from the air and become electrically conductive. The deliquescent point varies by particle composition. For example, ammonium sulfate has a deliquescence point of 40% relative humidity. The deliquescent point for ammonium nitrate, the most common type of particle found in California, occurs at a humidity of 65%. While sulfate particles can be expected to always be conductive in data centers, high humidity has the potential to activate the nitrate particle as well.

This project measured server equipment exposure to particulate matter in typical California data centers to better understand what level of particle concentration is actually present. Particle and humidity measurements were taken at eight different data centers in the Bay Area between May and November, 2006. These measurements provide insight into the typical particle concentrations in currently operating data centers and how particle concentrations change as air enters the data center from outside and then travels through the HVAC system. Two of the data centers had economizer capability or were adding them during the period of this study. This allowed the monitoring to help determine how significant increases in outside air flowing through the data center affect particle concentrations. Outcomes from this project contribute to understanding the reliability risk associated with airborne particulate matter in data centers and how economizer use alters this reliability risk.

## Methodology & Procedure

Conditioning in data centers is often provided by Computer Room Air Conditioning (CRAC) units, where the entire air handling unit (AHU) is situated on the data center floor. In most cases, air enters the top of the CRAC unit, where it passes through a series of filters and is then conditioned. The conditioned air is then supplied to the servers through a raised floor plenum. Fans within the servers pull air through the servers. The warmed air then stratifies toward the ceiling and eventually makes its way back to the intake of the CRAC unit. Most air circulation in data centers is internal to the data center zone. The majority of data centers are typically designed to have only a small portion of outside air enter the data center. Some data centers provide no ductwork for outside air to directly enter the data center area. Rather, outside air is only provided by infiltration from adjacent zones, such as office space. Other data centers, however, have challenged this paradigm by using large air handlers such as used in commercial buildings and have taken advantage of the benefit of using outside air for cooling.

*Figure 1: Data center layout with CRAC unit and minimal outside air*

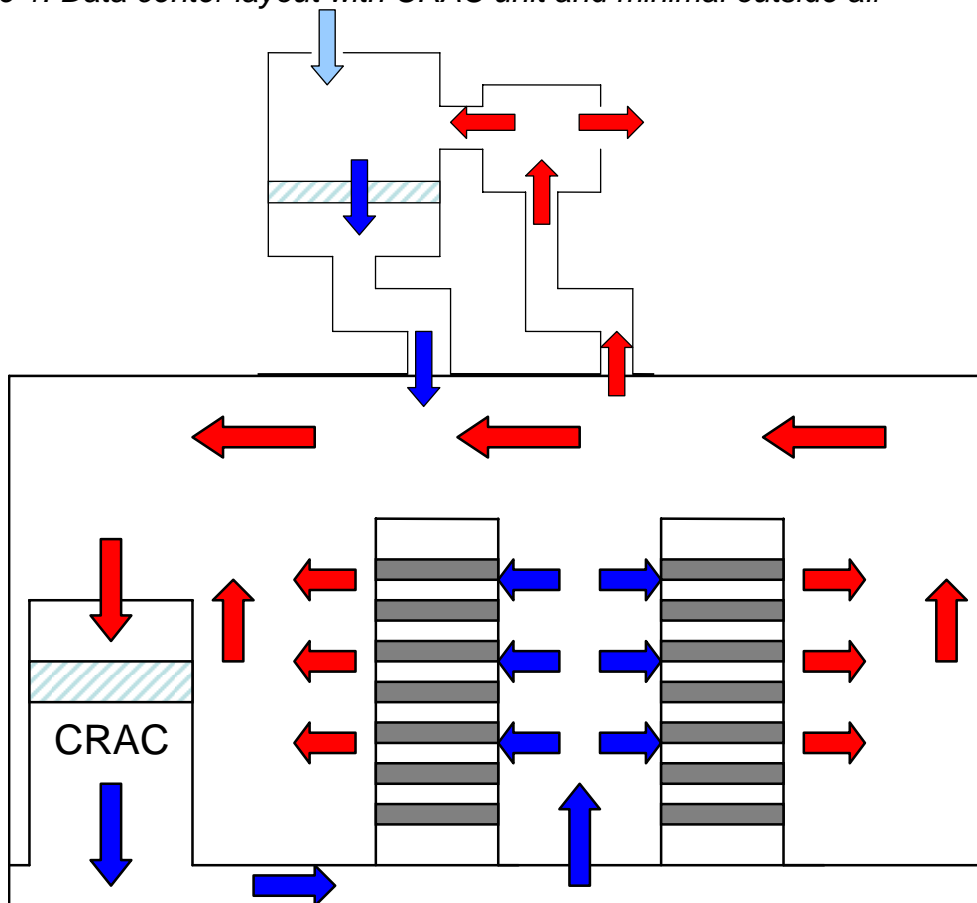

Particle counters were placed at three to four different locations within each data center evaluated in this study to understand particle concentration variations between the different centers. Humidity was monitored at many of the sites to determine if economizers affect humidity control. HOBO temperature and humidity data loggers were borrowed from the PG&E lending library in San Francisco to monitor the data centers. The monitoring locations were as follows:

1. **Server Rack:** A particle counter was placed to measure the particle concentration entering the servers. The particle counter was typically placed on the floor or on top of the server rack, with the intake tube extended in front of a server rack at a height of approximately 3 ft.
2. **Return Vent:** A particle counter was placed to represent the ambient indoor particle concentration in the data center. Depending on the HVAC configuration of the data center, the particle counter was either placed at a return vent or near the intake of a CRAC unit
3. **Outdoor:** A particle counter was placed to monitor the outdoor particle concentration. The intent was to measure the outside air particle concentration entering the building. The particle counter was typically placed within the ductwork or the air handling unit at the outside air intake and prior to any filtration.
4. **Outdoor - after filtration:** A particle counter was placed to measure the filtration efficiency of the outside filter and determine the particle concentration of the outside air entering the data center interior. This was not possible at some of the sites monitored, since the outside air was mixed with return air before passing through any filtration, thus making the particle concentration a function of the outside air return air ratio. At these locations a fourth particle counter was not used.

Particle concentrations were measured using four Met-One 237B optical particle counters. The particle counters were factory calibrated prior to monitoring the data centers. The monitoring equipment was also tested at the end of the project by insuring that each particle counter produced similar results under the same conditions. The particle counters provided size-resolved counts for five different size bins depending on particle diameter: 0.3-.5  $\mu\text{m}$ , 0.5-.7  $\mu\text{m}$ , 0.7-1.0  $\mu\text{m}$ , 1.0-2.0  $\mu\text{m}$ , and 2.0-5.0  $\mu\text{m}$ . The particle mass concentration was estimated by assuming a log-normal mass distribution of the particles for each size bin. Assuming this type of mass distribution allows the mass median diameter to be calculated as the geometric mean of each bin. The particle density is assumed to be 1.5  $\text{g}/\text{cm}^3$ . Equation 1 shows the mass concentration was calculated by adding up the mass from each size bin,  $i$ . The mass for each size bin is calculated as the product of the particle count (PC), particle density ( $\rho$ ), and mass median volume, where the particle diameter,  $D_i$ , is the geometric mean for the size bin.

Measurements at most sites were taken in 25 minute increments, where air is pulled through the particle counter at a rate of 0.1 ft<sup>3</sup>/sec for five minutes. The counter then pauses for 20 minutes before beginning the next particle counting cycle. Sample counting times were initially shorter. At the first two sites monitored, Lawrence Berkeley National Laboratory (LBNL) and LBNL's National Energy Research Scientific Computing Center, particles were counted for 20 minutes (rather than five minutes). Under these longer counting times the particle count for 0.3-0.5 μm particle size range reached the counter limit for many of the outdoor measurements. This indicates that the measured outdoor concentration under represents the actual outdoor particle concentration. However, the under representation is expected to be minimal at these two sites, since the 0.3-0.5 μm particle size range is a small contributor to the total outside particulate matter mass (typically less than 10% for the data centers monitored in this study).

*Equation 1: Particle count to mass concentration conversion*

$$MassConc = \sum PC_i \left( \rho \frac{\pi}{6} D_i^3 \right)$$



## Findings

Particle monitoring was conducted at eight different centers in Northern California. The average particle concentrations measured at each location are shown in Table 1. The indoor concentration in Table 1 represents the concentration at the server rack. A discussion of individual findings from each data center follows.

*Table 1: Average particle concentrations at each monitoring location*

		0.3-5.0 $\mu\text{m}$ Mean Particle Concentration ( $\mu\text{g}/\text{m}^3$ )					
		Outdoor			Indoor		
	Location	2.50%	Mean	97.50%	2.50%	Mean	97.50%
1	Redwood Shores	6.0	17.1	53.1	0.5	0.9	1.5
2	Walnut Creek	3.7	18.2	35.6	0.1	0.2	0.4
3	Rocklen	9.6	22.6	50.0	0.1	0.4	2.0
4	LBNL	12.4	28.1	46.0	0.3	0.3	0.4
5	LBNL-NERSC	4.2	14.9	27.2	0.1	0.2	0.3
6	San Francisco	3.2	5.0	7.3	0.6	1.0	1.8
7a	Dublin	0.4	1.6	5.3	0.2	0.3	0.5
7b	Dublin	2.9	24.5	75.0	0.3	3.7	13.6
8a	Sunnyvale	22.1	36.7	55.3	1.6	2.4	3.4
8b	Sunnyvale	6.8	33.3	73.4	0.7	6.5	16.6

### Center 1

Particle measurements were taken at a corporate park in Redwood Shores, CA from September 29 to October 6, 2006. The building the data center is located in is less than one mile from a major freeway, placing the site in close proximity to significant vehicular emissions. Air within the data center is conditioned by passing through CRAC units located on the data center floor. A small percentage of outside air enters the data center through ceiling vents. The entering air is a mixture of outside air and return air that has passed through a filter in a rooftop AHU.

The measured outdoor particle concentration averaged about  $17 \mu\text{g}/\text{m}^3$ , with 95% of the measurements falling between approximately  $6 \mu\text{g}/\text{m}^3$  and  $53 \mu\text{g}/\text{m}^3$  during the monitoring period. A few measurements showed concentrations reaching  $100 \mu\text{g}/\text{m}^3$ . Both the indoor ambient particle concentration (measured at the intake of one of the CRAC units) and the particle concentration at the server are similar throughout the measuring period. The indoor particle concentration averages about  $0.9 \mu\text{g}/\text{m}^3$  and 95% of the measurements between  $0.5$  and  $1.5 \mu\text{g}/\text{m}^3$ . The indoor particle concentration essentially toggles from  $1.0 \mu\text{g}/\text{m}^3$  during the day to about  $0.5 \mu\text{g}/\text{m}^3$  in the evening and early morning hours. The elevated concentration during the day is most likely due to occupants working in the data center.

*Figure 2: Center 1 outdoor particle concentration*

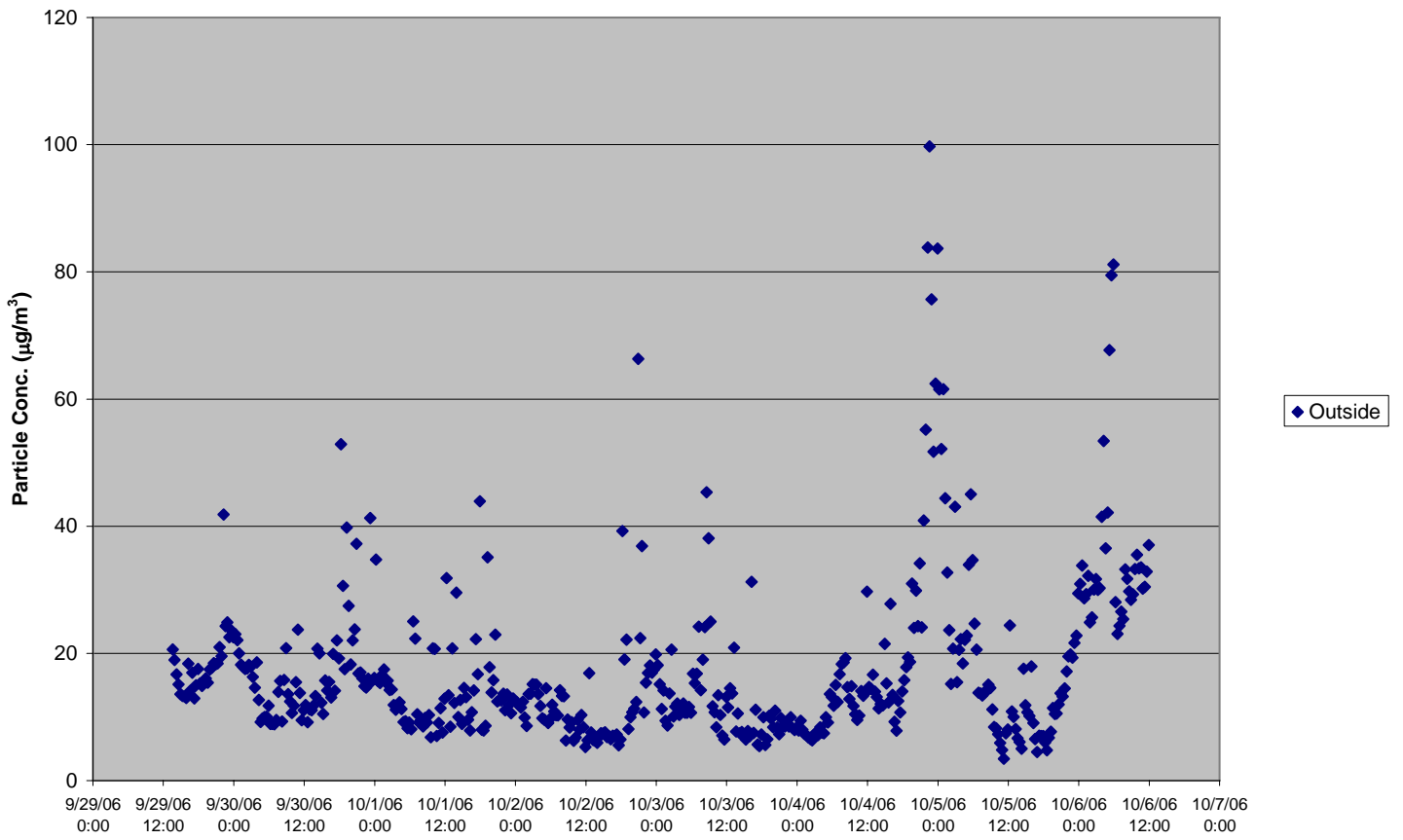
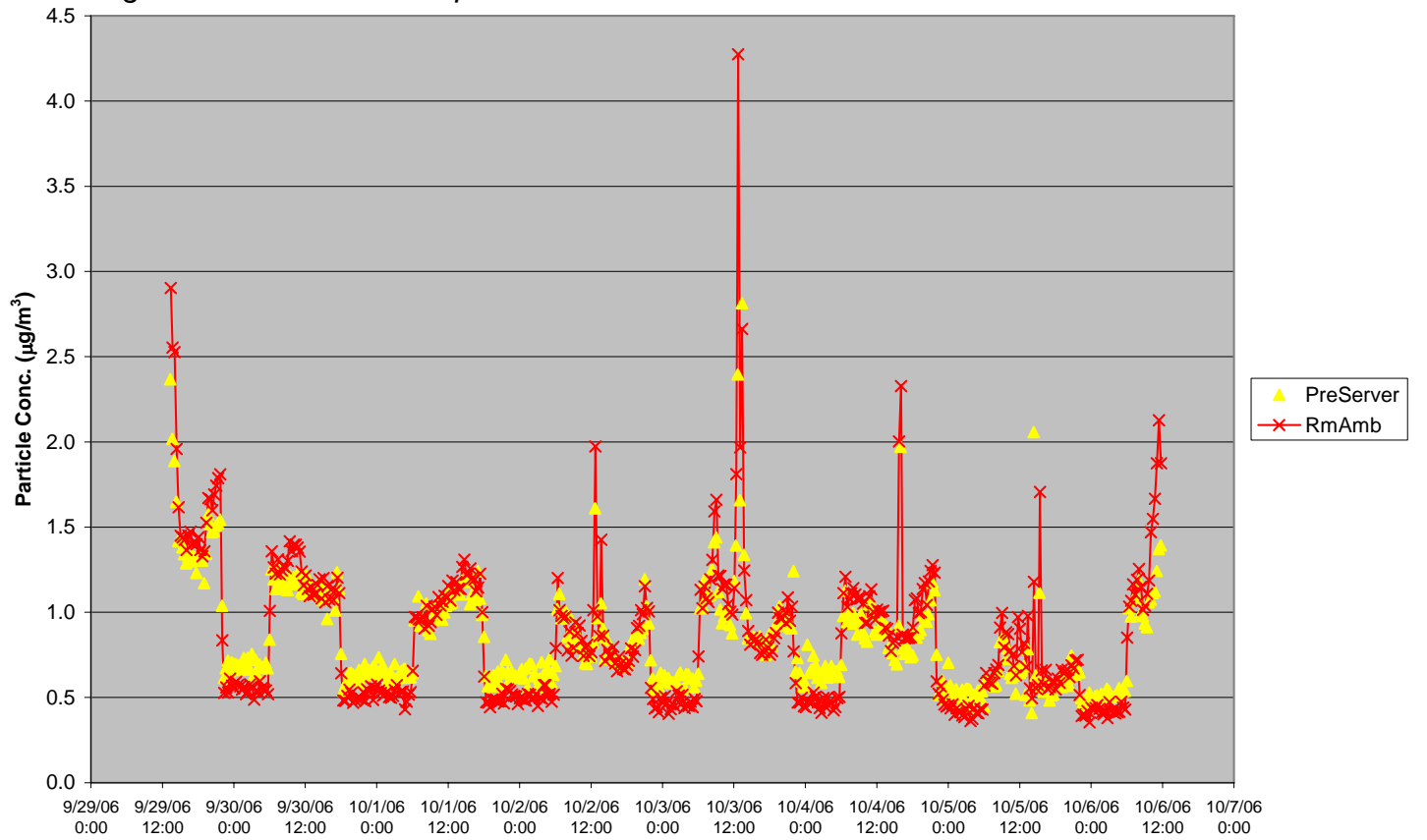

Figure 3: Center 1 indoor particle concentration



## Center 2

Particle measurements were taken at a data center building in Walnut Creek, CA from October 13 to October 20, 2006. Air is circulated within the room and conditioned with CRAC units on the data center floor. No direct outside air is ducted into the data center zone. Infiltration is the only source of outside air to the data center.

The average outside particle concentration measured at the Walnut Creek center is just under  $20 \mu\text{g}/\text{m}^3$ , with 95% of the measurements falling between approximately  $5 \mu\text{g}/\text{m}^3$  and  $40 \mu\text{g}/\text{m}^3$  during the monitoring period. A few measurements greater than  $100 \mu\text{g}/\text{m}^3$  were also taken. Both the indoor ambient particle concentration (measured at the intake of one of the CRAC units in the data center) and the particle concentration at the server are similar throughout the measuring period. The indoor particle concentration is fairly steady, with an average concentration of about  $0.2 \mu\text{g}/\text{m}^3$  and 95% of the measurements between  $0.1$  and  $0.4 \mu\text{g}/\text{m}^3$ . Only one measurement of the ambient indoor concentration reached a level greater than  $1.0 \mu\text{g}/\text{m}^3$ . Measurements at the server never exceeded  $0.5 \mu\text{g}/\text{m}^3$ .

Figure 4: Center 2 outdoor particle concentration

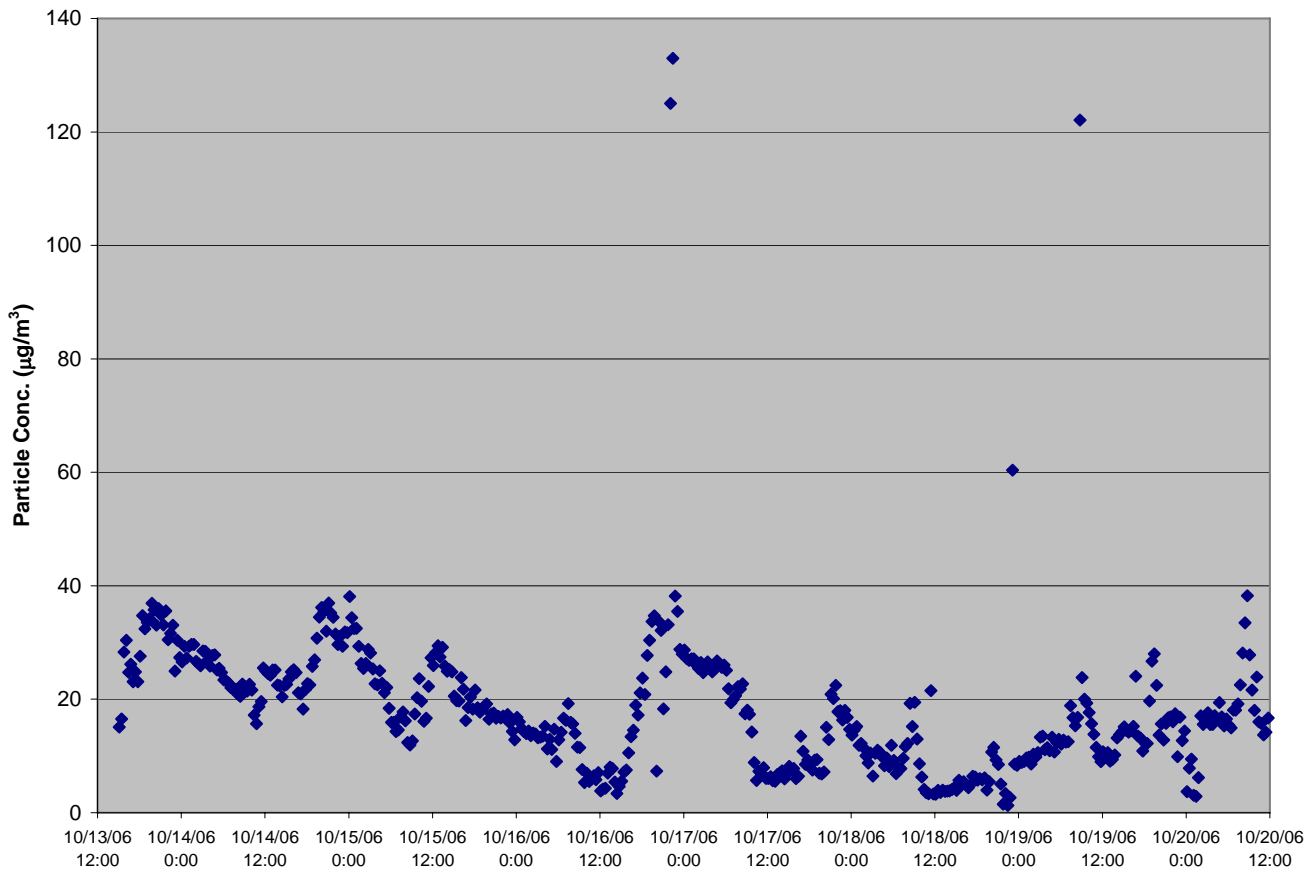
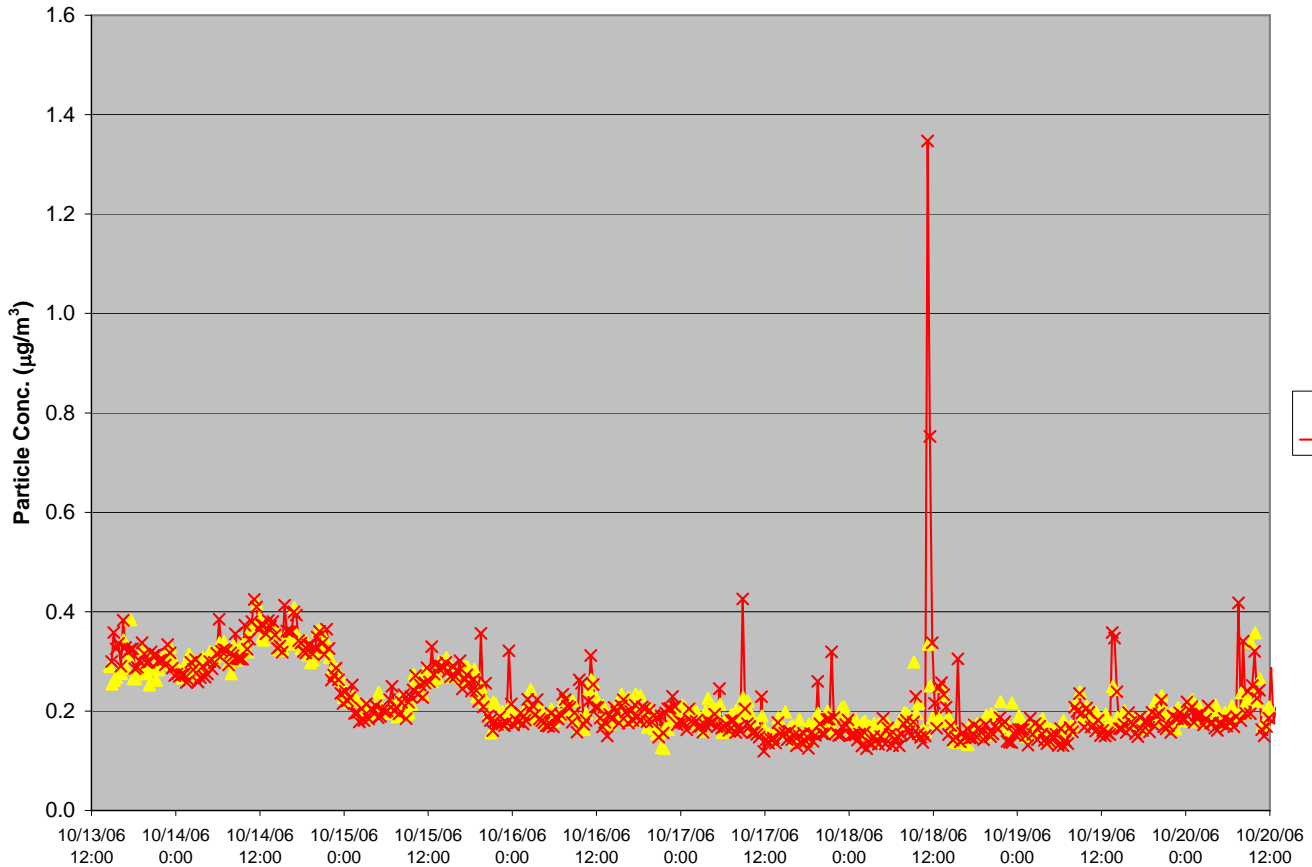

Figure 5: Center 2 outdoor particle concentration



### Center 3

Particle measurements were taken at a corporate data center building in Rochlen, CA (located just outside of Sacramento, CA) from September 14 to September 21, 2006. Air within the data center is conditioned by passing through CRAC units located on the data center floor. A small percentage of outside air enters the data center through ceiling vents. The entering air is a mixture of outside air and return air that has passed through a filter in a rooftop AHU.

The average outside particle concentration measured at this data center is approximately  $23 \mu\text{g}/\text{m}^3$ , with 95% of the measurements falling between approximately  $10 \mu\text{g}/\text{m}^3$  and  $50 \mu\text{g}/\text{m}^3$  during the monitoring period. A few measurements nearly reached  $100 \mu\text{g}/\text{m}^3$  during the monitoring period. Both the indoor ambient particle concentration (measured at the intake of one of the CRAC units) and the particle at the server are similar throughout the measuring period. The indoor particle concentration is fairly steady, with an average concentration just below  $0.4 \mu\text{g}/\text{m}^3$  and 95% of the measurements between  $0.1$  and  $2.0 \mu\text{g}/\text{m}^3$ . The final day of monitoring showed slightly higher indoor particle concentrations and greater concentration variability, possibly due to increased occupant activity in the monitoring area.

Figure 6: Center 3 outdoor particle concentration

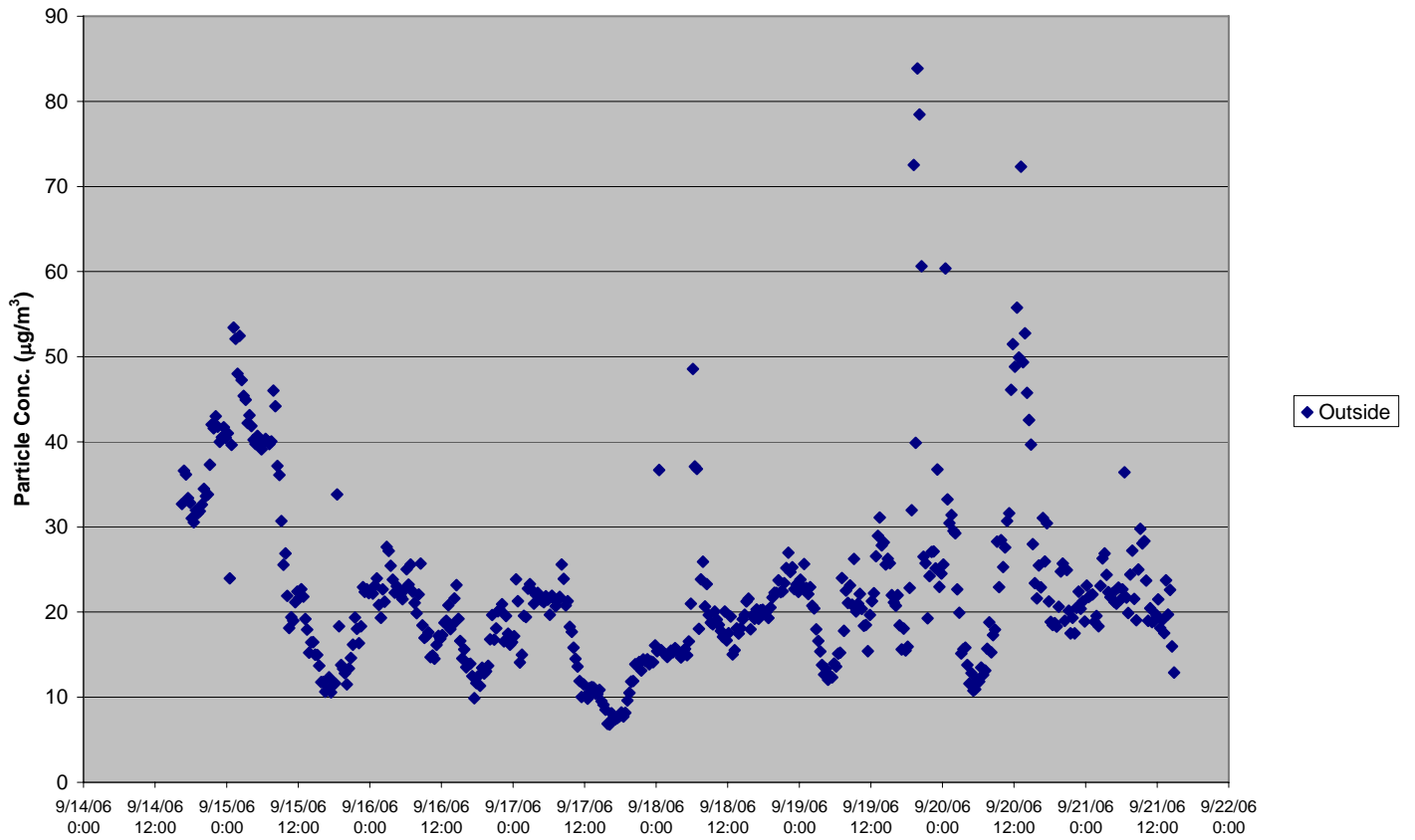
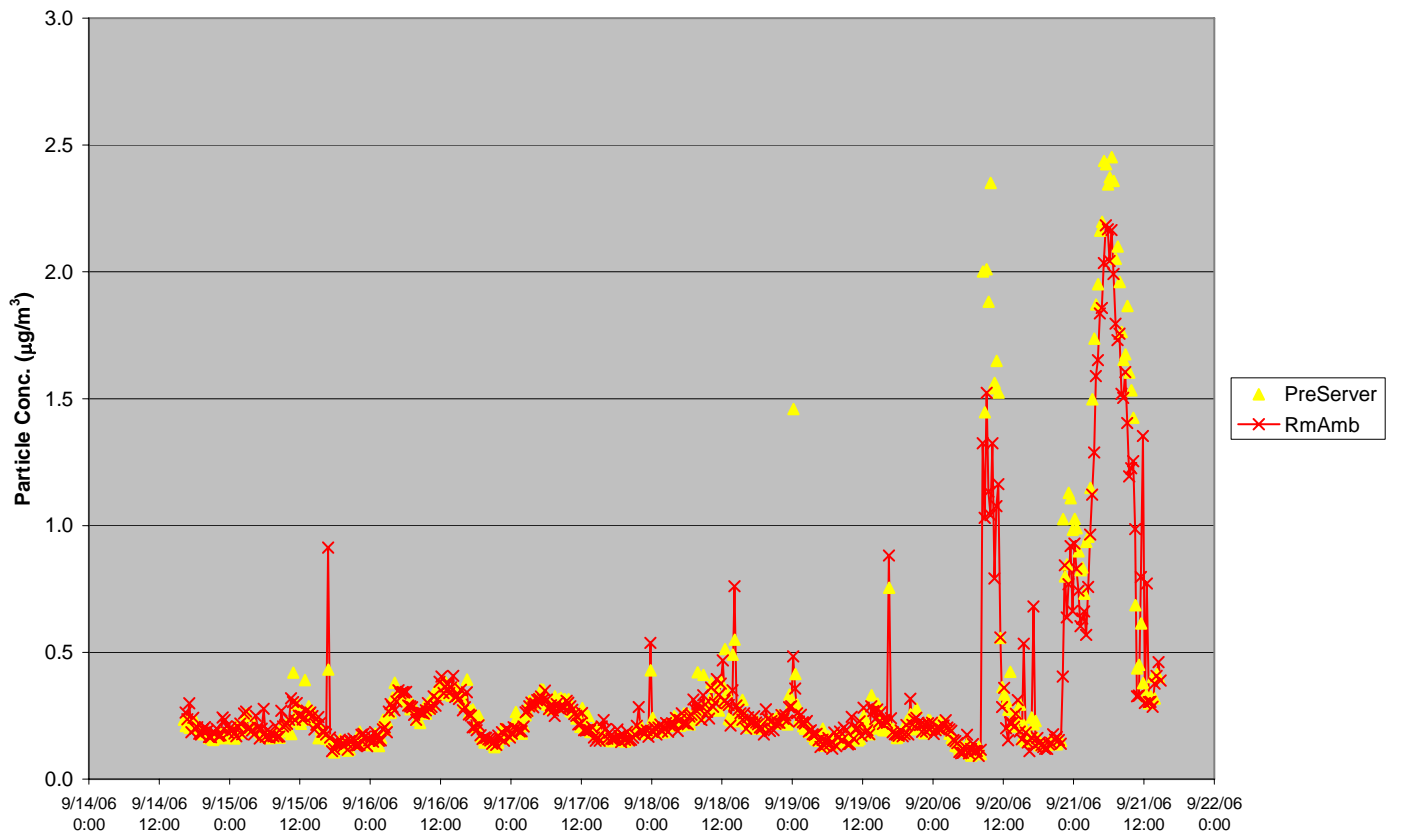

Figure 7: Center 3 indoor particle concentration



#### **Center 4**

Particle measurements were taken at Center 4 in Berkeley, CA between May 4 and May 8, 2002. The data center is situated within an office building and incorporates both floor CRAC units and the building's general HVAC system. A small percentage of outside air mixed with return air is directly ducted into the data center room, air within the room passes through CRAC units, and a small percentage of air is exhausted through a single large vent on the north side of the room. Exhausted air is returned to a mechanical room, where it is mixed with outside air that enters the mechanical room after passing through a filter. The mixture of filtered outside air and return air is then pumped back into the data center.

The particulate matter concentration measured in the outside air averages about  $28 \mu\text{g}/\text{m}^3$ , with 95% of the measurements falling between about  $12 \mu\text{g}/\text{m}^3$  and  $46 \mu\text{g}/\text{m}^3$  during the monitoring period. While monitoring the outside air at Center 4 data center the particle count for 0.3-0.5  $\mu\text{m}$  particle size range reached the counter limit for many of the measurements. This indicates that the measured outdoor concentration under represents the actual outdoor particle concentration. However, the under representation is expected to be minimal, since the 0.3-0.5  $\mu\text{m}$  particle size range is a small contributor to the total particulate matter mass (typically less than 10% for the data centers monitored in this study).

The indoor concentration is significantly steadier during this monitoring period. The particle concentration of air passing across the servers averaged about  $0.3 \mu\text{g}/\text{m}^3$  and 95% of the measurements at this location fluctuate by less than  $0.1 \mu\text{g}/\text{m}^3$  during the monitoring period. The ambient particle concentration in the room (measured at the large return vent on the north side of the room) is consistently about  $0.2 \mu\text{g}/\text{m}^3$  greater than at the servers for any given time period. Concentration fluctuations are slightly more exaggerated in the ambient air than the server air, with a few measurements showing the ambient room concentration momentarily increasing by about  $1 \mu\text{g}/\text{m}^3$ . In general, the fluctuations in the interior concentrations are minimal and are most likely caused by occupants in the data center.

Figure 8: Center 4 outdoor particle concentration

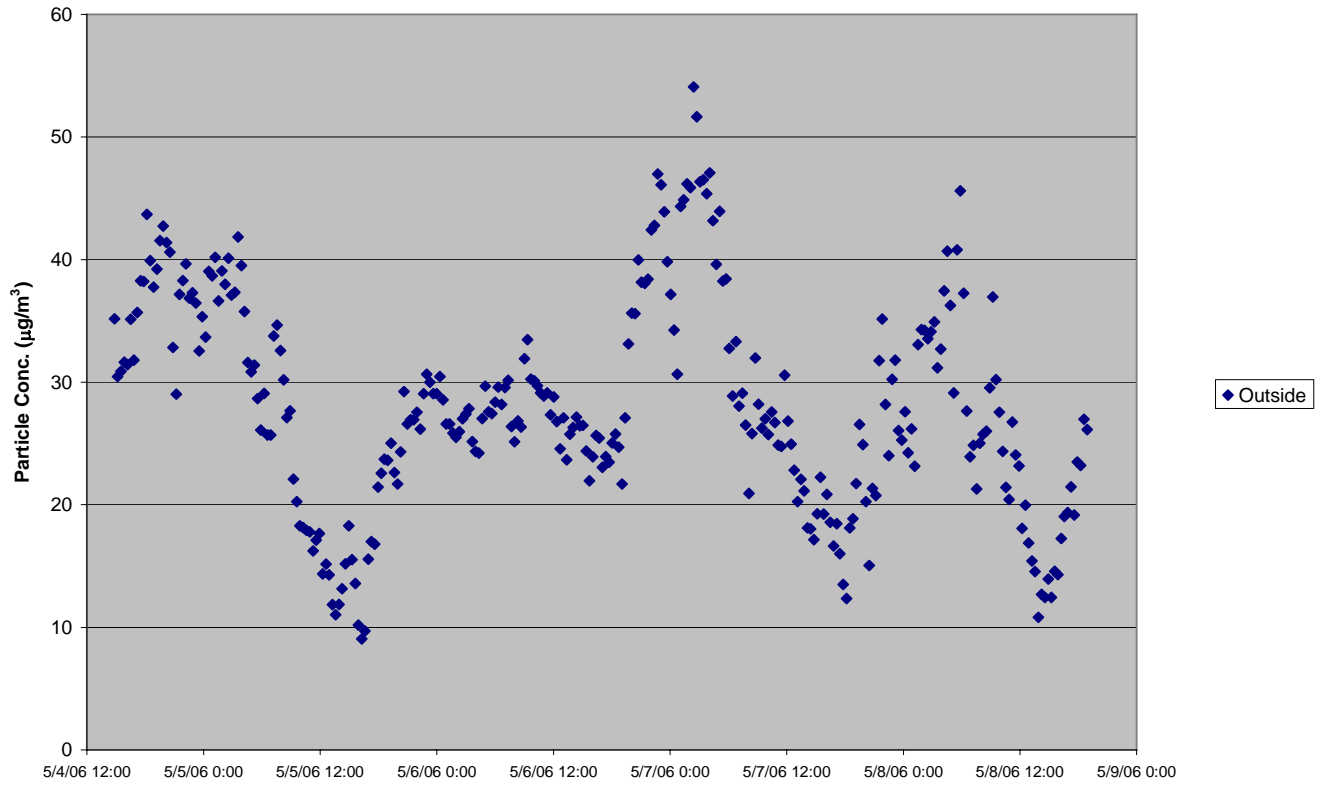
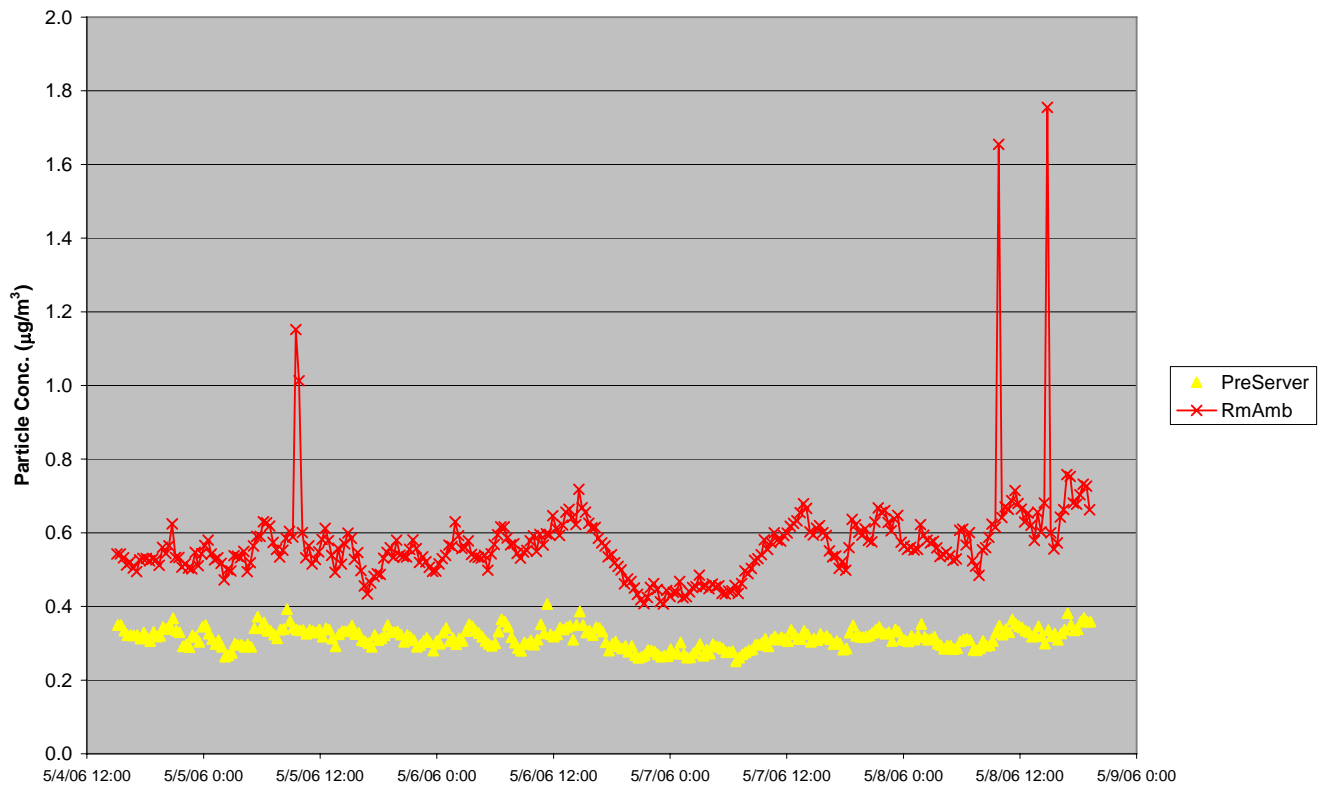

Figure 9: Center 4 indoor particle concentration



## Center 5

Particle measurements were taken at the Center 5 in Oakland, CA from May 15 to May 22, 2006. No direct outside air is ducted into the data center zone. Infiltration from adjacent office zones is the only source of outside air entering the data center. Within the room, air is circulated and conditioned with CRAC units.

The average outside particle concentration measured at Center 5 is approximately  $15 \mu\text{g}/\text{m}^3$ , with 95% of the measurements falling between approximately  $5 \mu\text{g}/\text{m}^3$  and  $30 \mu\text{g}/\text{m}^3$  during the monitoring period. No measurements greater than  $40 \mu\text{g}/\text{m}^3$  were recorded during the monitoring period. As with the LBNL monitoring, the particle count for 0.3-0.5  $\mu\text{m}$  particle size range reached the counter limit for many of the outdoor measurements, indicating that the measured outdoor concentrations under represents the actual particle concentration. However, the change to the measurements is expected to be minimal, since the 0.3-0.5  $\mu\text{m}$  particle size range is a small contributor to the total particle mass (typically less than 10% for all of the data centers monitored in this study).

Both the indoor ambient particle concentration (measured at the intake of one of the CRAC units) and the particle at the server are similar throughout the measuring period. The indoor particle concentration is relatively lower and steadier than the outdoor measurements, with an average concentration just below  $0.2 \mu\text{g}/\text{m}^3$  and 95% of the measurements between 0.1 and  $0.3 \mu\text{g}/\text{m}^3$ . The concentration and fluctuation is shown to decrease even more during the last two days of the monitoring period for both the indoor and outdoor particle measurement, though the simultaneous concentration decrease may not be correlated. The last two days of monitoring fall on a weekend. The lower outdoor concentration may be due to decreased vehicular emissions directly around the facility. The lower indoor concentration may be due to decreased occupant activity in the data center.



Figure 10: Center 5 outdoor particle concentration

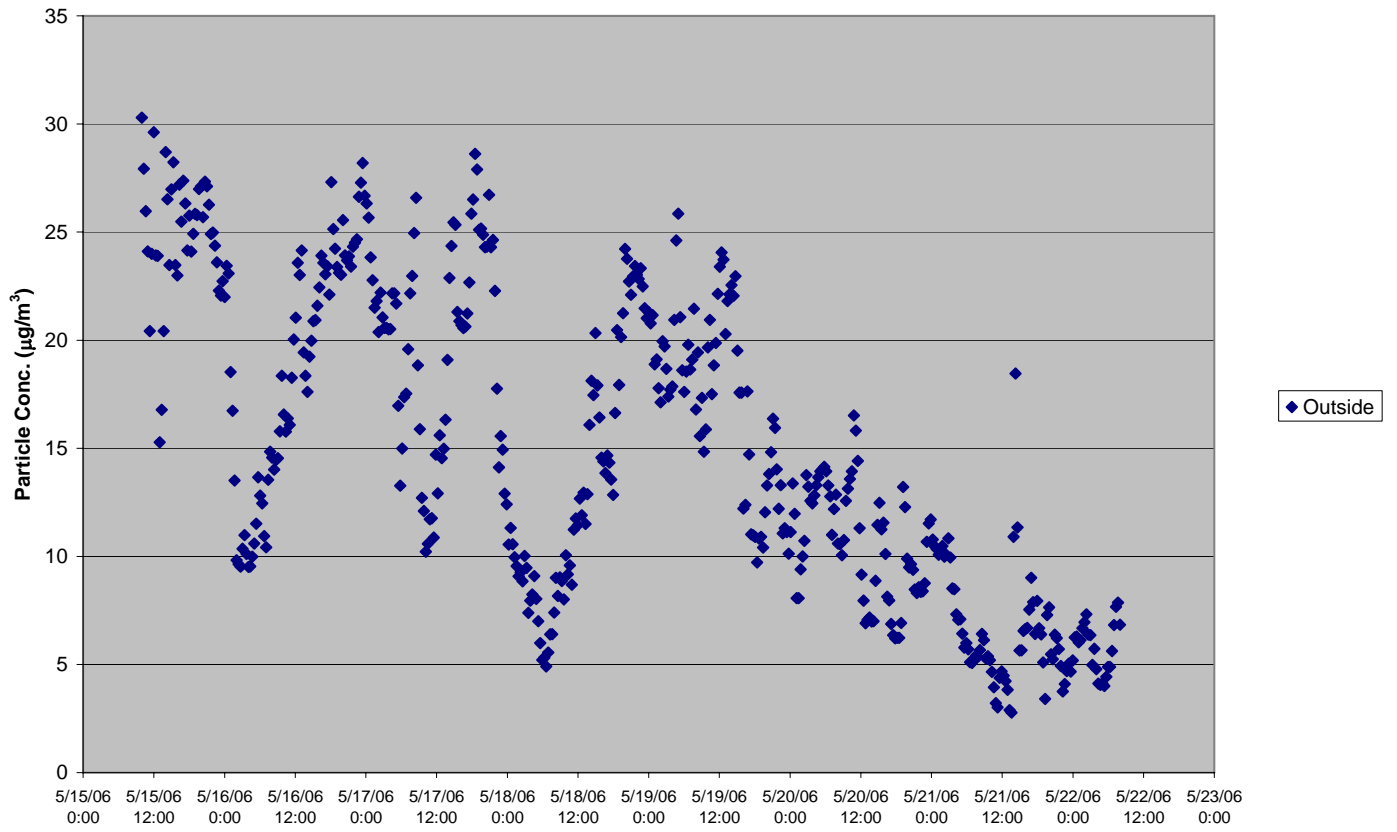
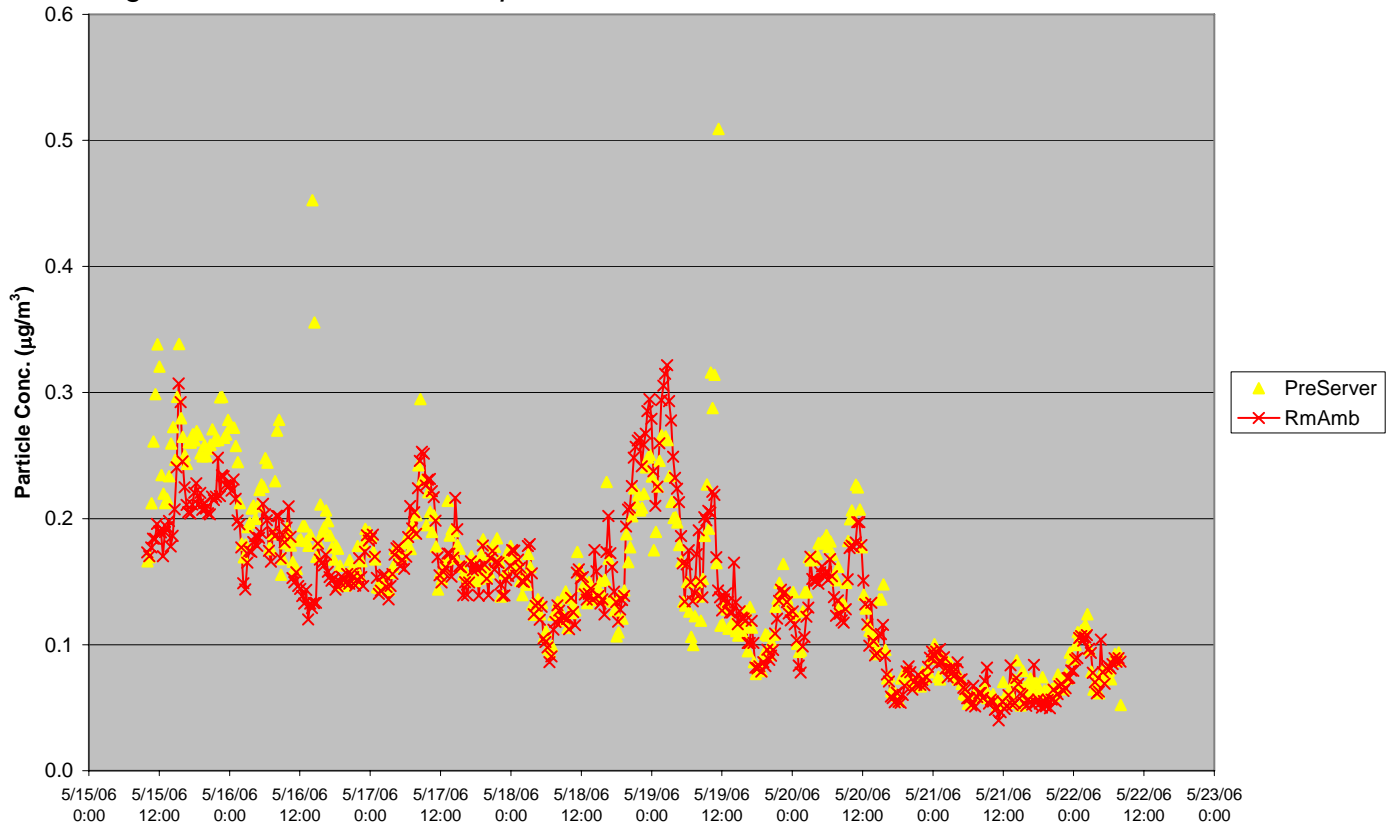

Figure 11: Center 5 outdoor particle concentration



## Center 6

Particle measurements were taken at Center 6 located in downtown San Francisco, CA from August 8 to August 10, 2006. Center 6 is located throughout various floors within a high-rise building. The outside intake for the building is located on eight floor. A small percentage of outside air enters some of the data center though ceiling vents, while other data center rooms receive no outside air directly ducted into the data center zone. The data center room that was monitored in this study received no direct outside air. Outside air can only enter the room from infiltration from adjacent zones. Air within the data center rooms are conditioned and internally circulated by passing through CRAC units located on the data center floor.

The average outside particle concentration measured at Center 6 is approximately  $5 \mu\text{g}/\text{m}^3$ , with 95% of the measurements falling between approximately  $2 \mu\text{g}/\text{m}^3$  and  $7 \mu\text{g}/\text{m}^3$  during the monitoring period. No measurements greater than  $10 \mu\text{g}/\text{m}^3$  were recorded during the monitoring period. While the outdoor concentrations at this location are one of the lowest outdoor concentrations measured in this study, the indoor concentration was among the highest for data centers not using economizers. Both the indoor ambient particle concentration (measured at the intake of one of the CRAC units) and the particle concentration at the server are similar throughout the measuring period, with the ambient concentration consistently registering slightly higher (about  $0.2 \mu\text{g}/\text{m}^3$ ) than the air at the server. The indoor particle concentration at the servers is fairly steady, with an average concentration of about  $1.0 \mu\text{g}/\text{m}^3$  and 95% of the measurements between  $0.6$  and  $1.8 \mu\text{g}/\text{m}^3$ .

Figure 12: Center 6 outdoor particle concentration

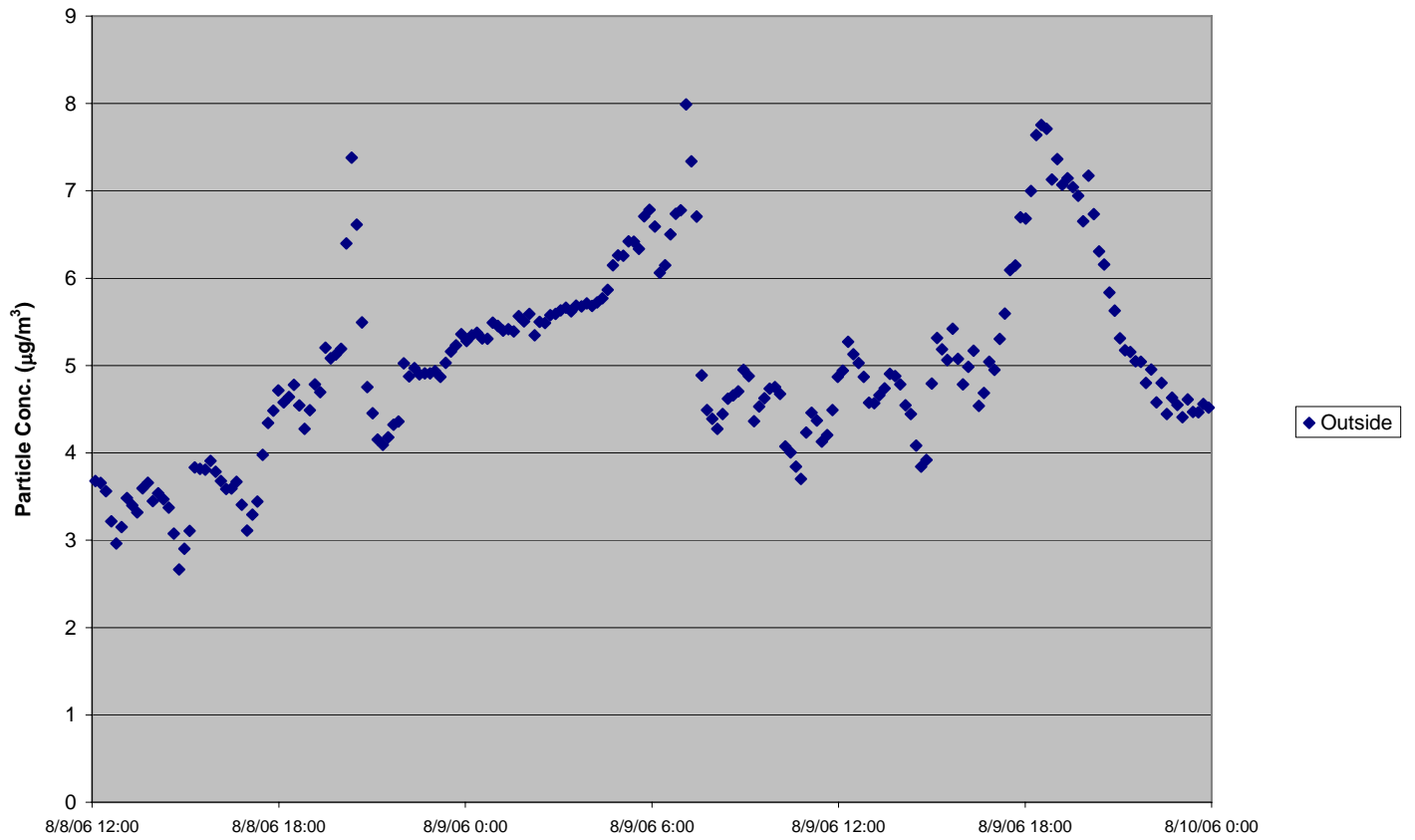
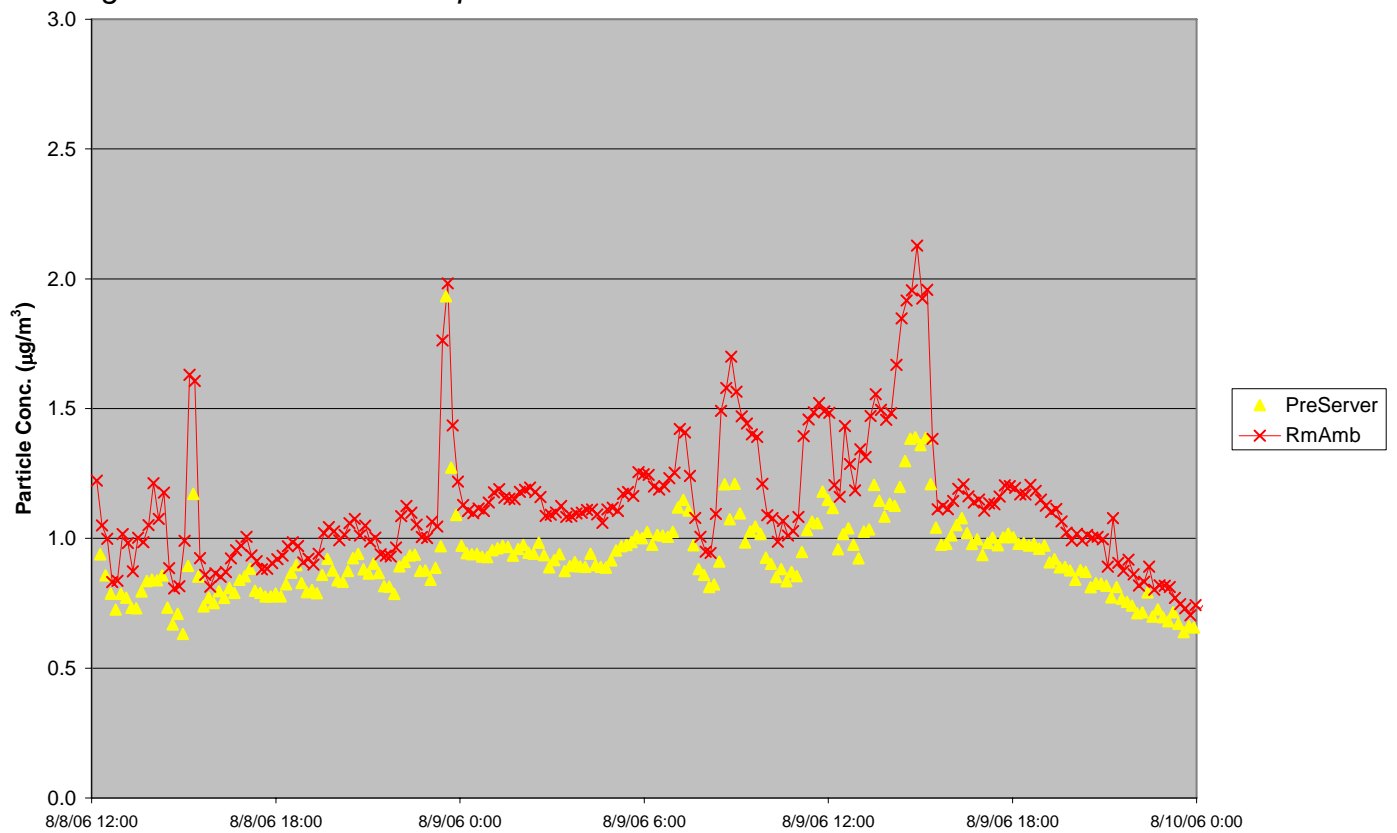

Figure 13: Center 6 indoor particle concentration



### **Center 7a (Prior to installation of economizer)**

Particle measurements were taken at Center 7 located in Dublin, CA from July 22 to July 24, 2006. Additionally, continuous monitoring was performed at this site using an Aircuity Optinet monitoring system (see section below). While much of the area surrounding Center 7 is undeveloped, the location is approximately one mile from a major freeway, placing the site in close proximity to potentially significant vehicular emissions. Air within the data center is conditioned by passing through CRAC units located on the data center floor. Before an economizer was installed, no direct outside air was ducted into the data center zone. The only source of outside air entering the data center came from infiltration through adjacent office zones.

The average outside particle concentration measured at Center 7 is approximately  $2 \mu\text{g}/\text{m}^3$ , with 95% of the measurements falling between approximately  $0.5 \mu\text{g}/\text{m}^3$  and  $5 \mu\text{g}/\text{m}^3$  during the monitoring period (Figure 14). This data matched fairly well with the Optinet measurements taken from this time period. Data from both measuring devices showed similar time trends. The particle counts between the two devices varied by about 50% on average, which is considered within the acceptable range of variability for particle counters. The two days of measurements were taken over a weekend period and the particle concentration makes a distinctive drop from Saturday, which averaged about  $4 \mu\text{g}/\text{m}^3$  during the day, to Sunday, where concentration averaged below  $1 \mu\text{g}/\text{m}^3$ .

The outdoor concentrations measured at center 7 were significantly lower than outdoor measurements from other locations in this study. Results from the Optinet measurements show that particle concentrations throughout the entire month of July are fairly similar, though the low concentrations measured on Sunday drop the MetOne measurements below the monthly average. The Optinet measurements show an average outdoor particle concentration of about  $4 \mu\text{g}/\text{m}^3$  for the month of July (Figure 15).

No abrupt change in indoor particle concentration is seen in the data from Saturday to Sunday. The indoor particle concentration is fairly steady, with an average concentration of about  $0.3 \mu\text{g}/\text{m}^3$  and 95% of the measurements between  $0.1$  and  $0.5 \mu\text{g}/\text{m}^3$  (Figure 16). Optinet indoor measurements for the entire month of July show that the weekend MetOne measurements are below the monthly average of  $0.1 \mu\text{g}/\text{m}^3$  (Figure 17). The ambient particle concentration in the room (measured at the intake of one of the CRAC units) is consistently about  $0.3 \mu\text{g}/\text{m}^3$  greater than the air at the servers. Concentration fluctuations for both the ambient concentration and the concentration at the server are more exaggerated during the Saturday daytime hours, indicating that the fluctuations in the interior concentrations may be caused by occupants in the data center.

The indoor concentration appear to be generally independent of outdoor concentrations, however, indoor concentrations do seem to be influenced by drastic changes in outdoor concentrations. For example, note that the sharp increase in outdoor particle concentration during July 4, 2006 is mimicked in the indoor concentration.

Figure 14: Center 7 outdoor particle concentration

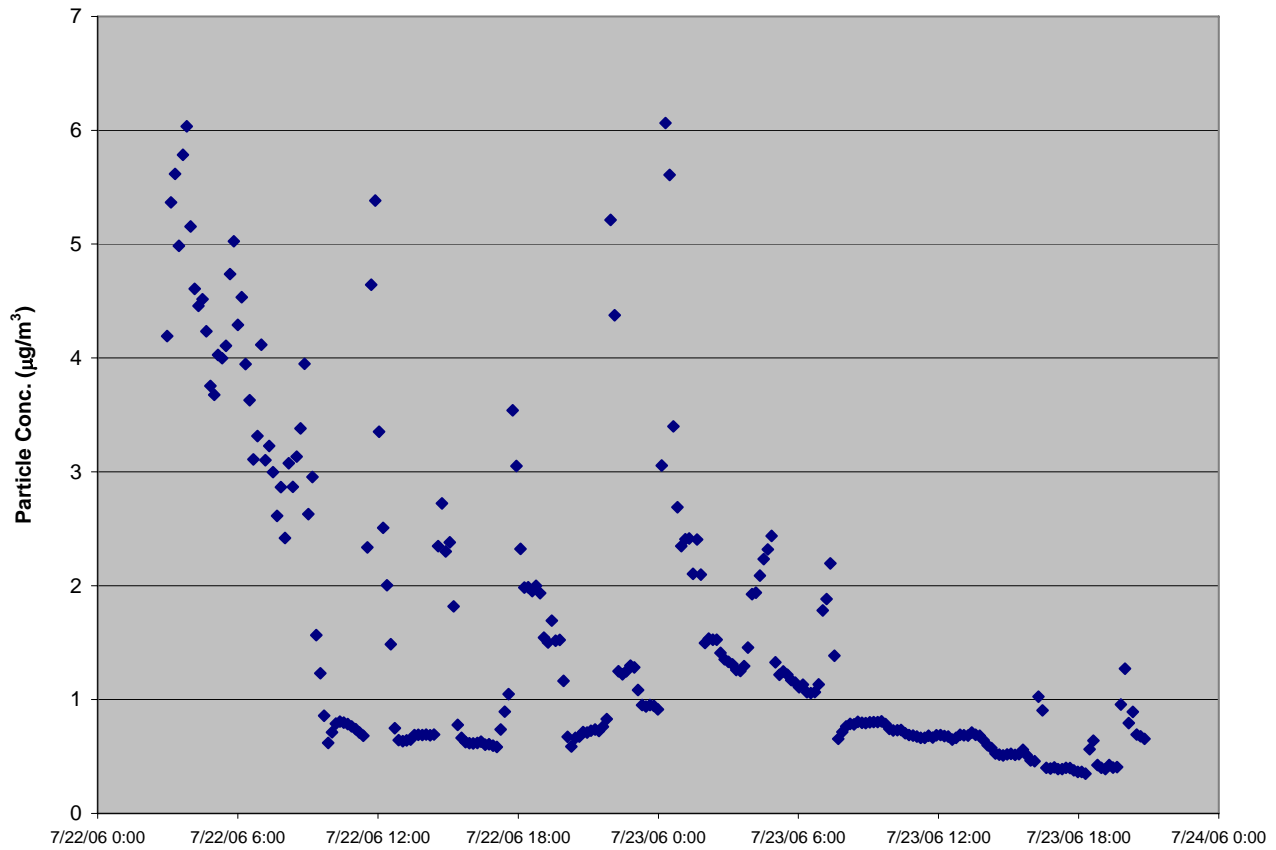

Figure 15: Center 7 Outside Optinet measurements for the month of July

0.3-2.5 Particulate Matter

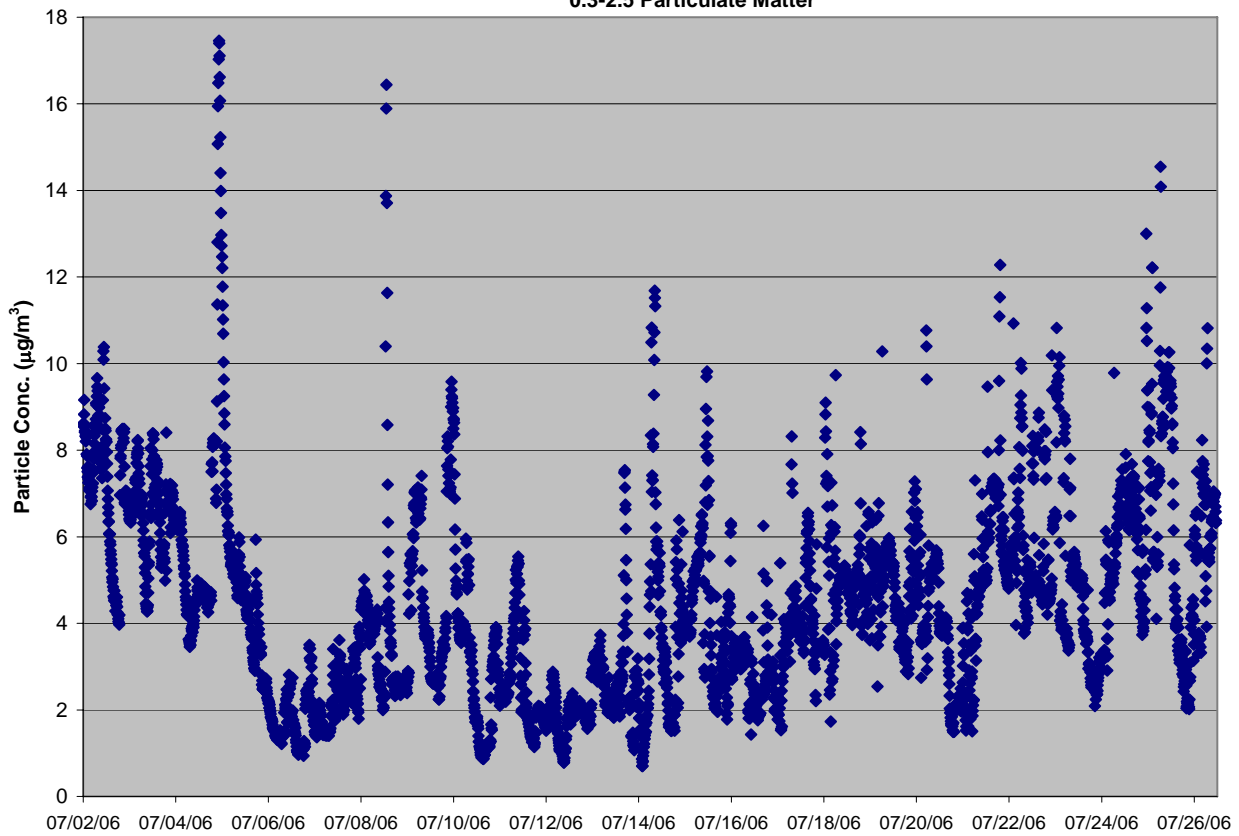

Figure 16: Center 7 indoor particle concentration

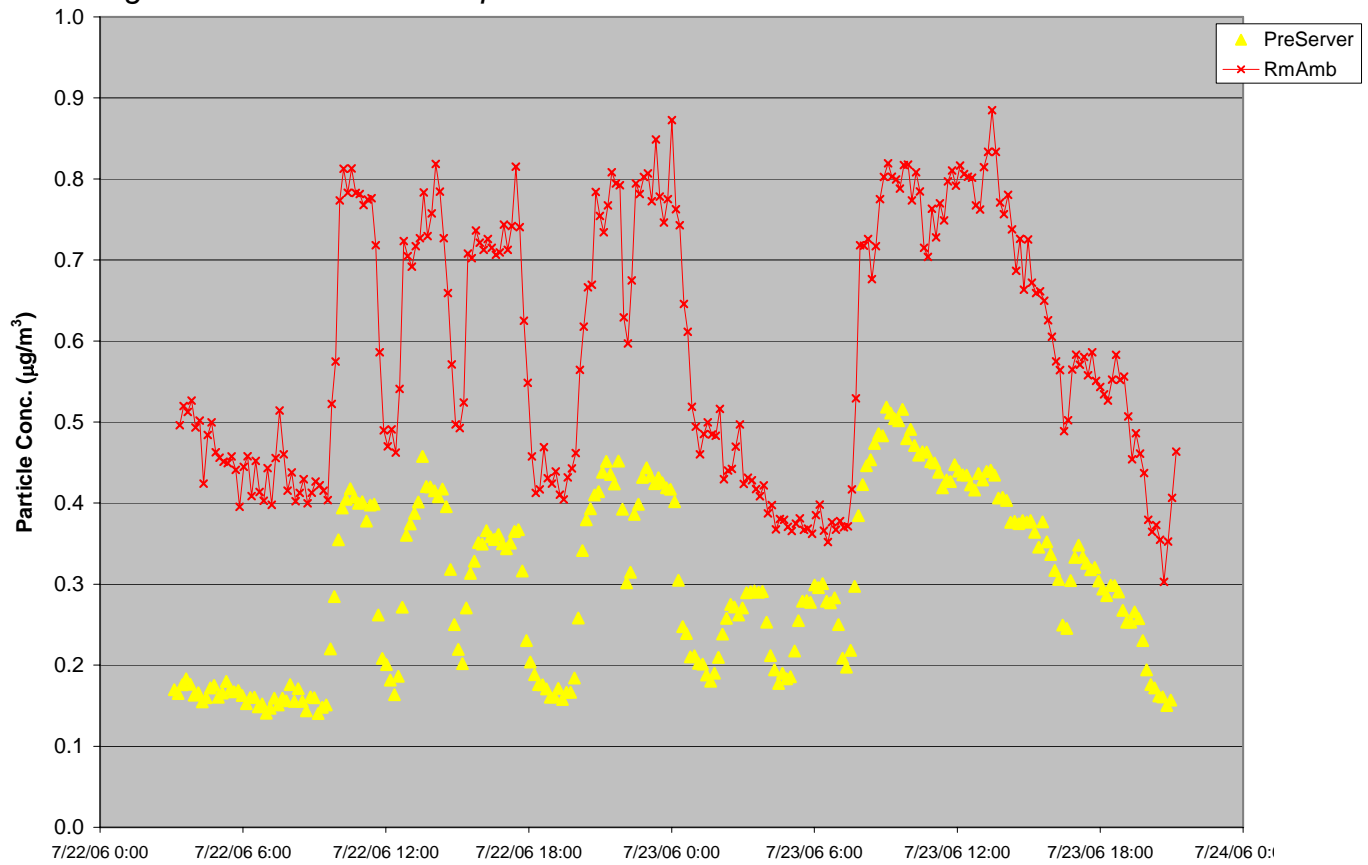
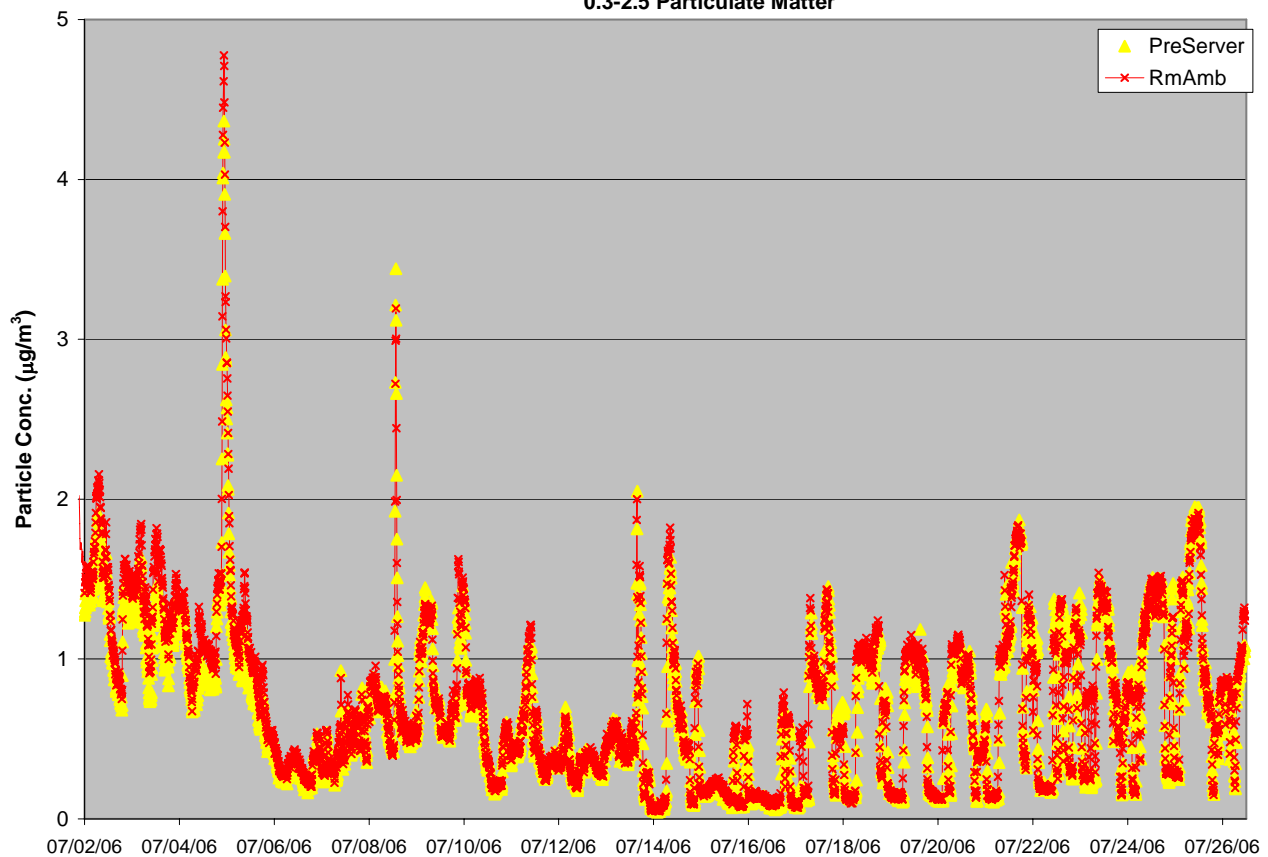

Figure 17: Center 7 Outside Optinet measurements for the month of July

0.3-2.5 Particulate Matter



### **Center 7b (economizers in operation)**

Economizers were installed at Center 7 in November, 2006. During cool weather periods outside air is supplied to the data center through ductwork along the ceiling. The cool outside air drops from the ceiling, where it then mixes with the warm air in the room. Since the outside air is administered from multiple ceiling locations, some of this air comes into immediate contact with the server equipment, while the rest of the outside air travels into the CRAC units. Air is removed from the data center zone through a large single exhaust vent positioned in the wall in the middle of the room

Once the economizers were operating, particle measurements were taken again at Center 7 from November 22 to December 5, 2006. The average outside particle concentration measured at Center 7 during this winter period is higher than the outside measurements taken during the summer. The average particle concentration is measured at  $24.5 \mu\text{g}/\text{m}^3$ , with 95% of the measurements falling between approximately  $3 \mu\text{g}/\text{m}^3$  and  $75 \mu\text{g}/\text{m}^3$  during the monitoring period (Figure 21).

Indoor particle concentrations at the server averaged about  $3.7 \mu\text{g}/\text{m}^3$ , and 95% of the measurements fell between  $0.3$  and  $16.3 \mu\text{g}/\text{m}^3$  (Figure 22). The indoor concentration changed significantly depending on the position of the economizer dampers. When the dampers were closed (no outside air supplied) the results are similar to the other data centers monitored that do not use economizers: the average particle concentration at the server was less than  $1 \mu\text{g}/\text{m}^3$  and appeared independent of the fluctuations in outdoor particle concentration. When the dampers opened and outside air was supplied, the concentration at the server quickly increased to approximately  $5$  to  $15 \mu\text{g}/\text{m}^3$ , and appeared dependent on the outside concentration. For example, when the outdoor was about  $20 \mu\text{g}/\text{m}^3$  the concentration at the server was about  $2 \mu\text{g}/\text{m}^3$ , but when the outdoor concentration increased toward  $80 \mu\text{g}/\text{m}^3$  the concentration at the server increased to about  $14 \mu\text{g}/\text{m}^3$ .

Indoor particle concentrations were measured at two locations in Center 7. Particle concentration measurements were similar at both locations when the economizer dampers were closed. When the dampers opened and outside air directly entered the data center, the particle concentration was consistently higher at the monitoring location near the servers, compared to the concentration at the CRAC intake. The increased concentration at the servers may be due to the positioning of the outside air ducts. Outside air is released far away from the CRAC unit being monitored, causing the outside air to first be taken in by other CRAC units. The monitor at the servers is directly exposed to incoming outside air, while the monitor at the CRAC unit measures air that has already passed through the under-floor air distribution and the CRAC unit filtration.

Figure 21: Center 7 outdoor particle concentration with economizer  
0.3-5 Particulate Matter

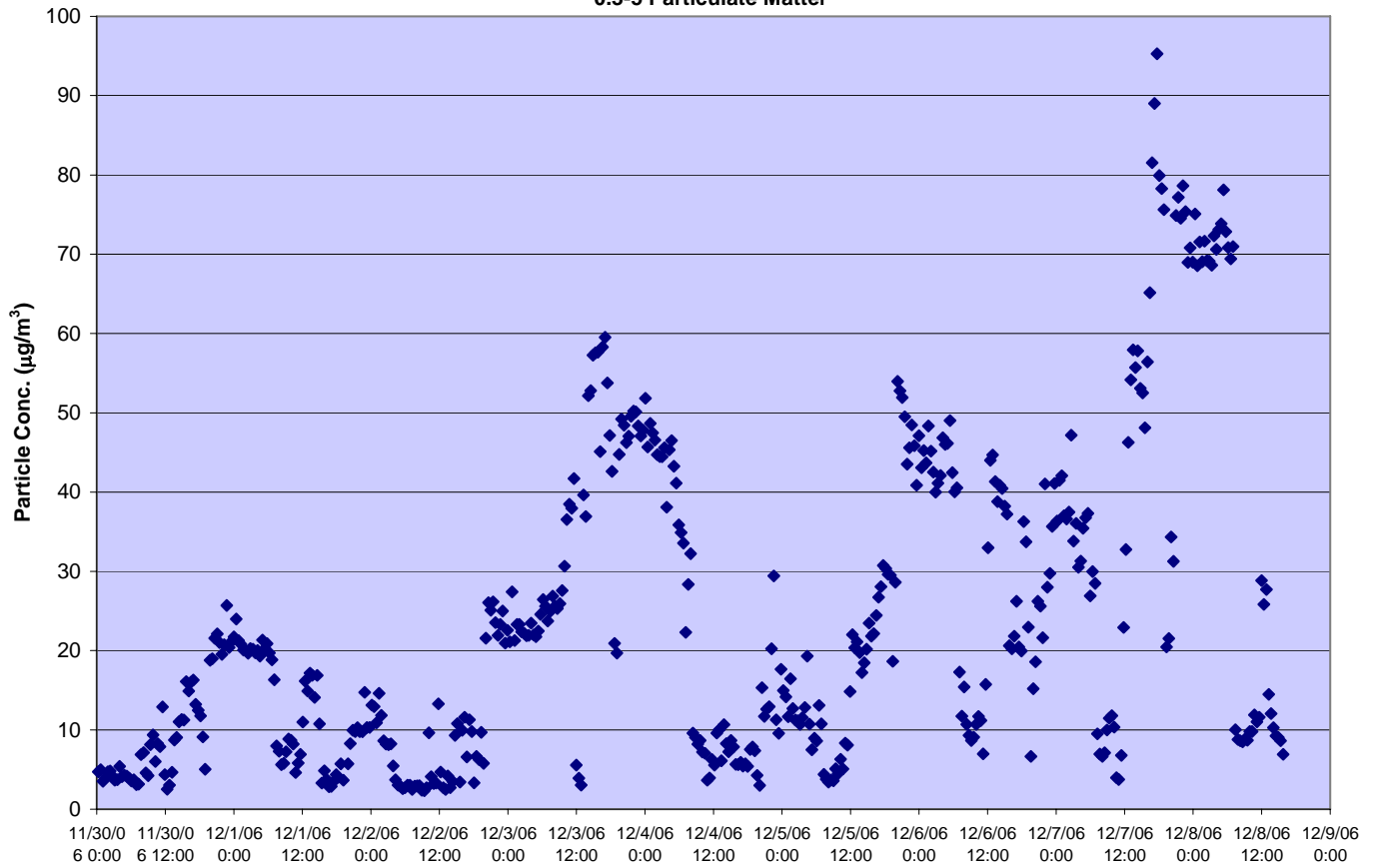
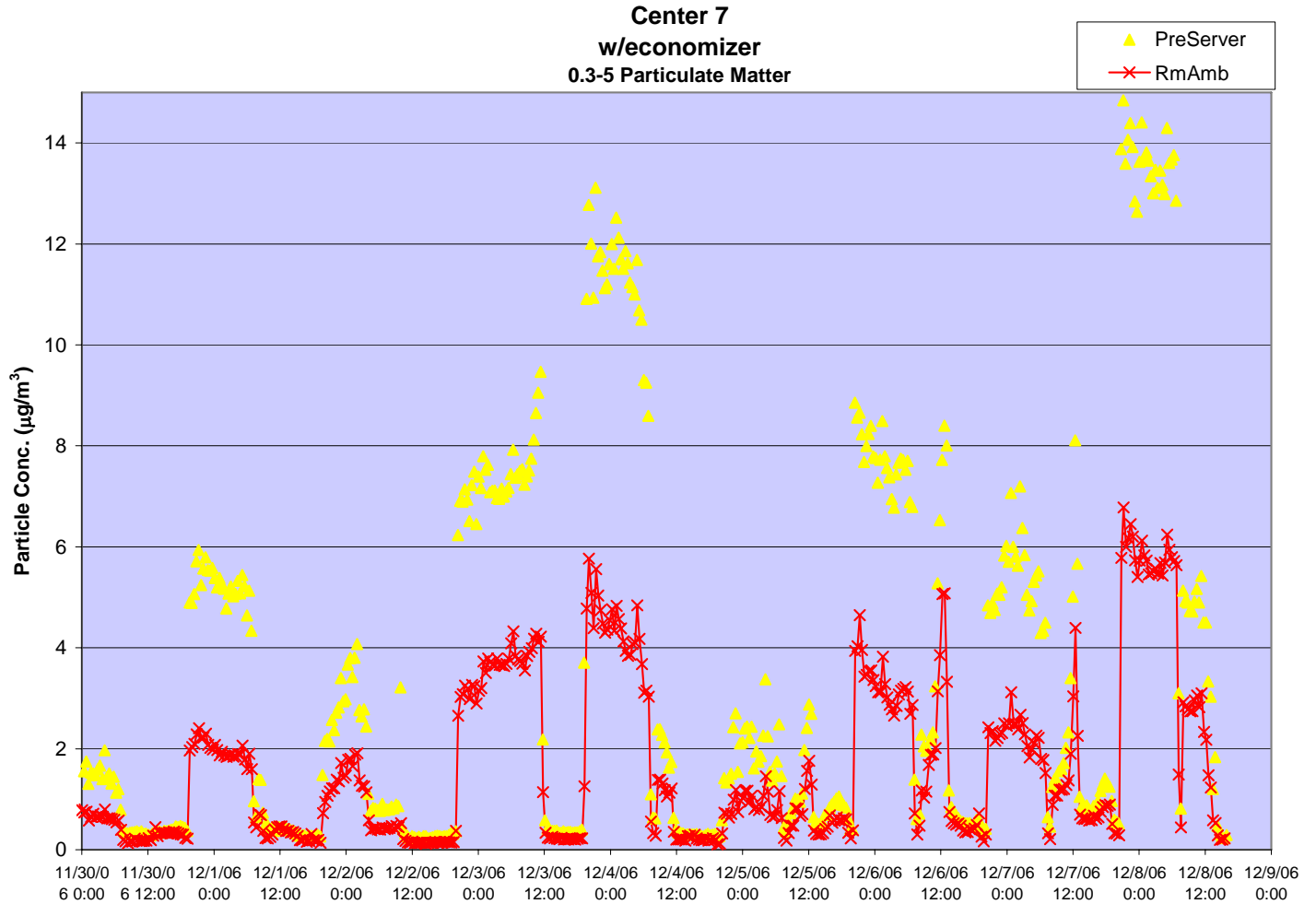



Figure 22: Center 7 outdoor particle concentration with economizer



### Optinet Facility Monitoring System

A stationary air monitoring system, designed by Aircuity, was installed at Center 7 in June, 2006. The system, officially named the Optinet Facility Monitoring System, provides real time monitoring of air temperature, humidity, particulate matter, and various gaseous air pollutants. Using a light scattering technology similar to the MetOne equipment, the Optinet system is designed to concurrently measure particle concentrations in multiple air samples. Optinet tubing was placed at each of the four monitoring locations used by the MetOne equipment at Center 7 (the Optinet system can accommodate up to 12 separate tubes). Each piece of tubing was 100 to 200 feet in length; traveling from its individual monitoring location to the central Optinet equipment located on the data center floor.

A comparison of the particle counts gathered from the Optinet and MetOne equipment is shown in Figures 18 and 19. The Optinet measurements followed similar time trends to the MetOne measurements, though particle counts between the two devices varied by about 50% on average, which is considered

within the acceptable range of variability for particle counters. The Optinet measurements were typically lower than the MetOne measurements, which are believed to be caused by a difference in calibration between the two types of equipment.

Particle deposition in the long tubing used in the Optinet System can theoretically skew particle measurements, though this does not appear to be the cause the differences between the Optinet and MetOne measurements. The Optinet System was fitted with a long and short tube to determine if the long tubing influenced the number of particles being measured. The long tube was approximately 100 feet in length and was draped back and forth in 25 foot increments. The short tube was about 3 feet long. The ends of both tubes were positioned to measure the same location in the data center. Results from this comparison are shown in Figure 20. The longer tube consistently measured slightly less particles than the shorter tube, indicating some deposition was occurring. The particle counts measured varied by less than 5% between the two tubes, indicating that the level of deposition was nominal.

The apparent minimal deposition occurring in the long tubes of the Optinet system may be due to particle reuptake promoted by the high air velocities in the tubing. The system is designed to first pull air through the tubes at a rate of 30 ft/sec, then slow down to a rate of 3 ft/sec while the air sample is analyzed. The high velocity of airflow is turbulent and designed to minimize the amount of particles that may deposit onto the inner surface of the tubing while traveling to the central Optinet equipment.

Figure 18: Center 7 indoor particle concentration

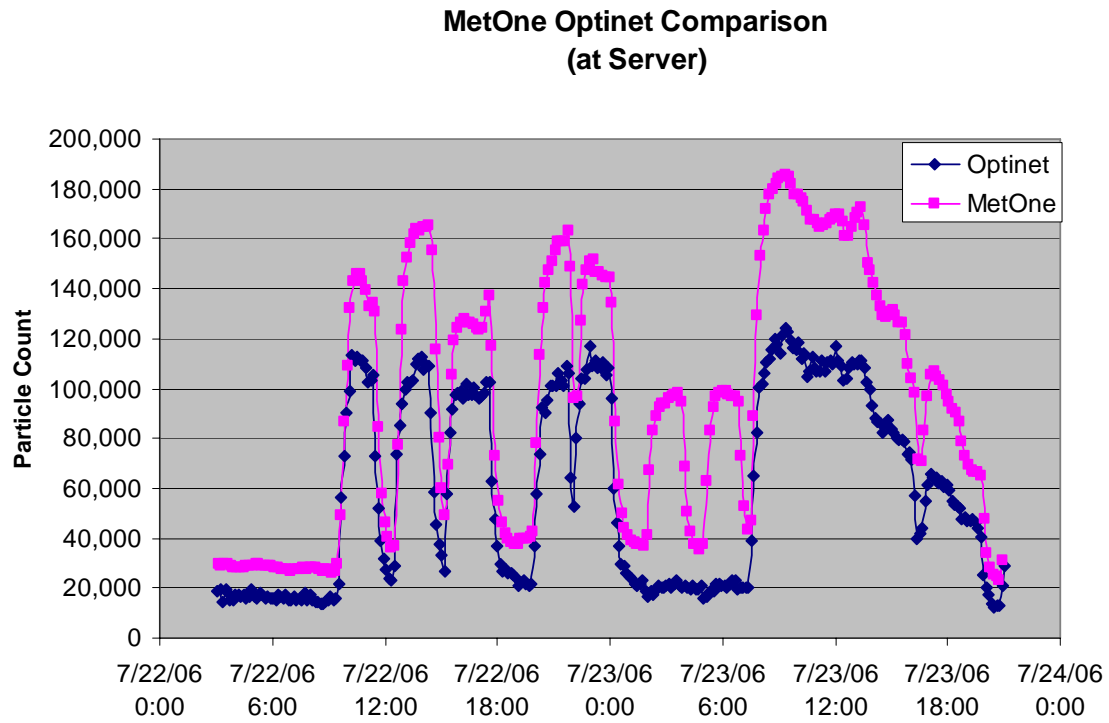

Figure 19: Center 7 outdoor particle concentration

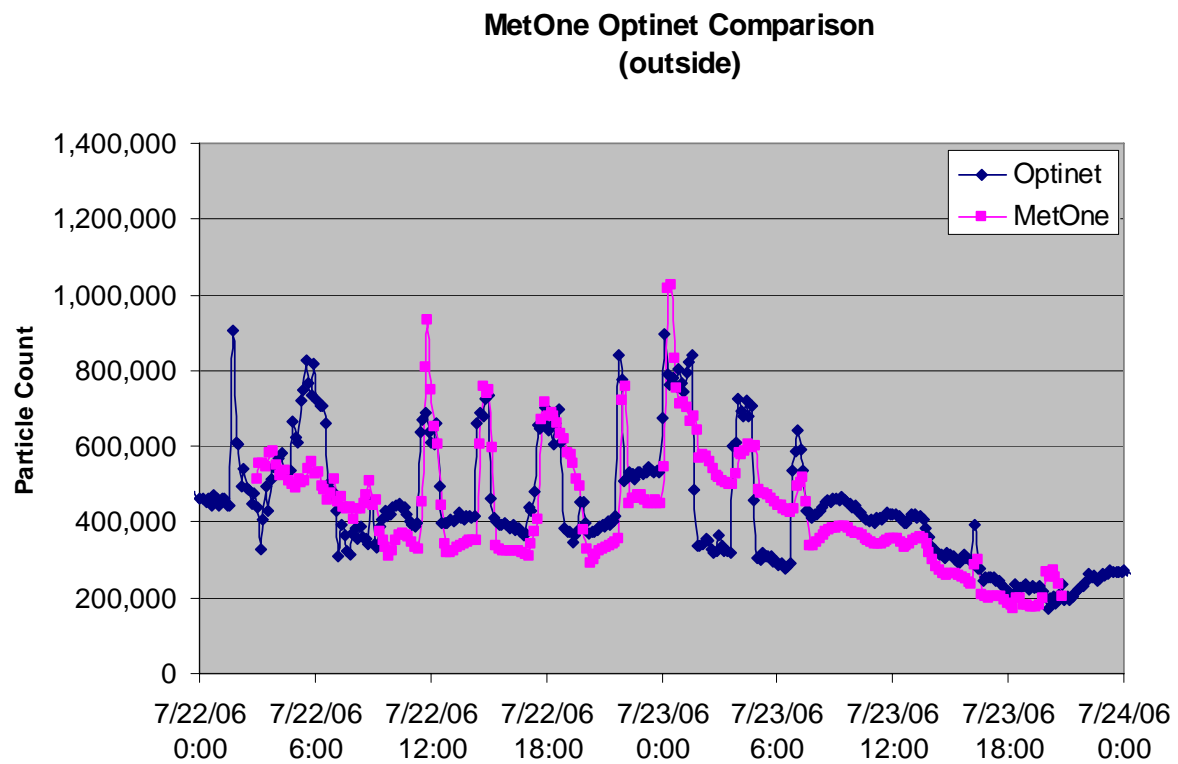
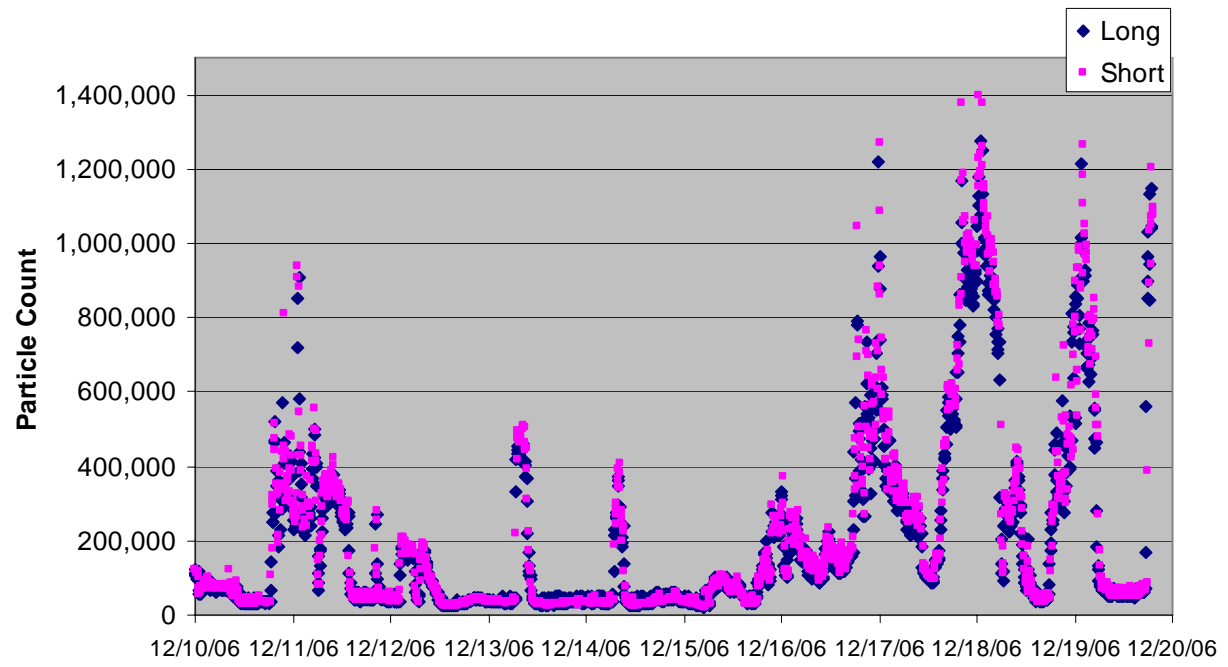

Figure 20: Optinet Tube Comparison



## **Center 8**

Particle measurements were taken at Center 8 in Sunnyvale, CA from October 13 to October 20, 2006. Unlike the other data centers evaluated in this study, Center 8 does not use traditional CRAC AHUs. Rather, conditioned air is ducted into the room and supplied through ceiling vents. After air passes through the servers, warm air is removed from the room through ceiling vents and returned to the AHUs, which are located in a mechanical room adjacent to the data center. At the AHU, some of the return air is exhausted while the rest is mixed with outside air, and passed through a series of filters, then conditioned and supplied to the data center again. The system is fitted with an economizer, allowing the amount of outside air to adjust depending on outside conditions. When the outside temperature drops below the setpoint temperature the percentage of outside air entering the system greatly increases. Current practice sets the setpoint temperature low enough that the system always provides minimal outside air. After the first day of monitoring, the economizer temperature setpoint was adjusted to allow the system to switch from providing 15% outside air to 85% outside air during late night and early morning hours. The first day of monitoring is considered Center 8a measurements and the remaining days are considered Center 8b measurements.

### **Center 8a (without economizer operating)**

During the first day of monitoring (8/18/06) the average outside particle concentration measured at the Sunnyvale site was about  $37 \mu\text{g}/\text{m}^3$ , with 95% of the measurements falling between approximately  $12 \mu\text{g}/\text{m}^3$  and  $55 \mu\text{g}/\text{m}^3$ . The indoor concentration during this period, when the system provided 15% outside air, was similar to the other data centers monitored that do not use economizers: the average particle was measured  $2.4 \mu\text{g}/\text{m}^3$ , with 95% of the measurements falling between approximately  $1.6 \mu\text{g}/\text{m}^3$  and  $3.4 \mu\text{g}/\text{m}^3$ .

### **Center 8b (with economizer operating)**

After the first day the economizer temperature setpoint was adjusted to activate economizer use. During this period the average outside particle concentration measured at the Sunnyvale site was about  $33 \mu\text{g}/\text{m}^3$ , with 95% of the measurements falling between approximately  $7 \mu\text{g}/\text{m}^3$  and  $74 \mu\text{g}/\text{m}^3$ . A few measurements reached as high as  $100 \mu\text{g}/\text{m}^3$  during the monitoring period. Indoor particle concentrations at the server averaged about  $6 \mu\text{g}/\text{m}^3$ , and 95% of the measurements fell between  $0.7$  and  $16 \mu\text{g}/\text{m}^3$ . However, similar to Center 7, the indoor concentration changed significantly depending on the amount of outdoor air entering the data centers. When the system provided 15% outside air the results were similar to the first day of monitoring (Center 8a): the average particle concentration at the server was approximately  $2 \mu\text{g}/\text{m}^3$  and appeared independent of the fluctuations in outdoor particle concentration. When the economizer dampers opened and supplied 85% outside air the concentration at the server quickly increased to approximately  $11 \mu\text{g}/\text{m}^3$  and was highly dependent on the outside concentration. For example, when outdoor conditions were about  $6 \mu\text{g}/\text{m}^3$  the concentration at the server was about  $3 \mu\text{g}/\text{m}^3$ , but when

the outdoor concentration increased toward  $100 \mu\text{g}/\text{m}^3$  the concentration at the server increased to about  $20 \mu\text{g}/\text{m}^3$ .

Indoor particle concentrations were measured at three locations at Center 8. The locations were in the AHU (after the air passes through the system filter), at the server, and at the return vent. All three monitoring locations show very similar changes in concentration over time. For any given time the particle concentration at the server was lower than the concentration in the AHU and higher than the concentration in the return vent. This is possibly due to particles depositing as air moves through the supply duct and across the server equipment.

Figure 23: Center 8 outdoor particle concentration

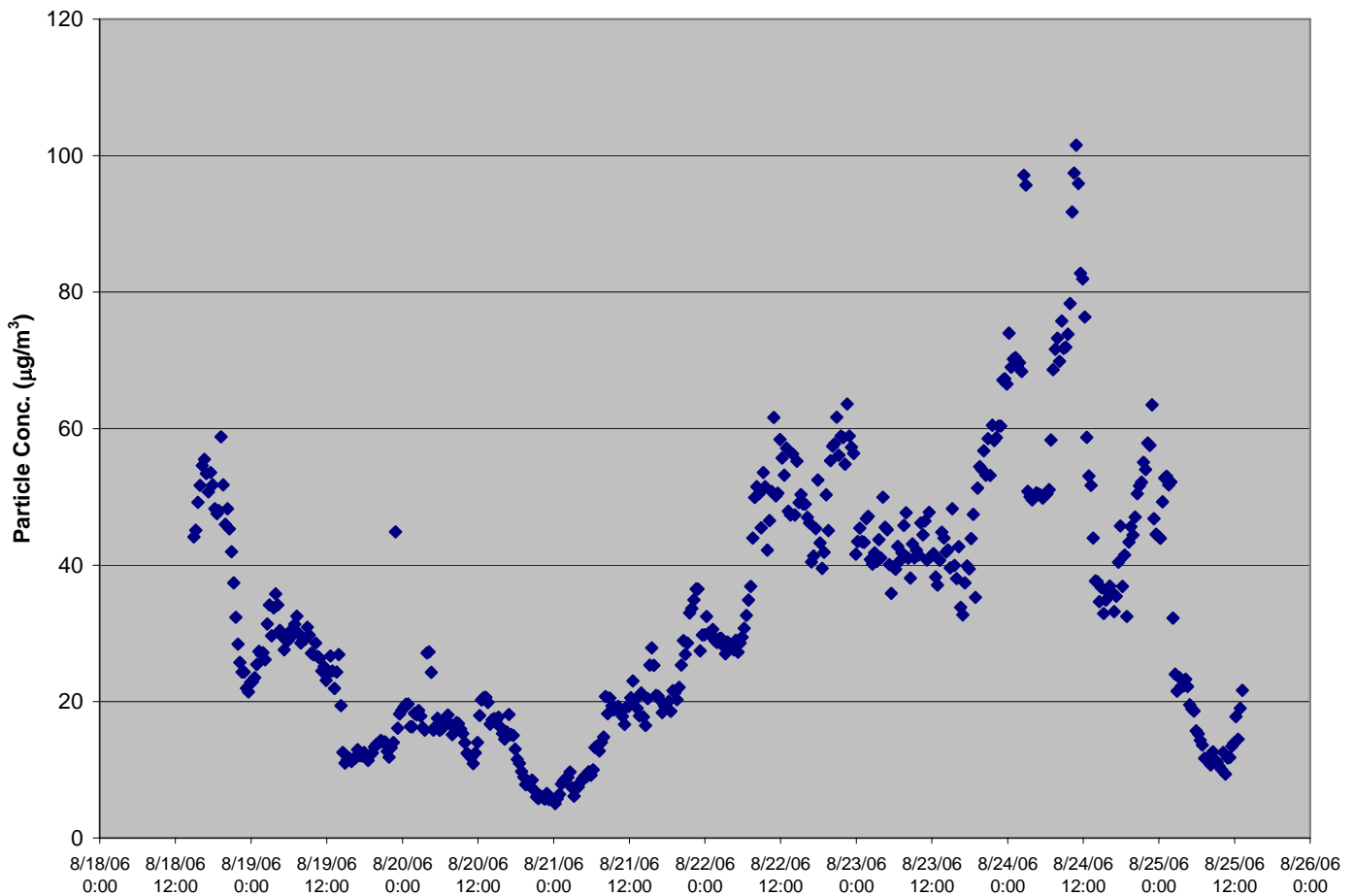
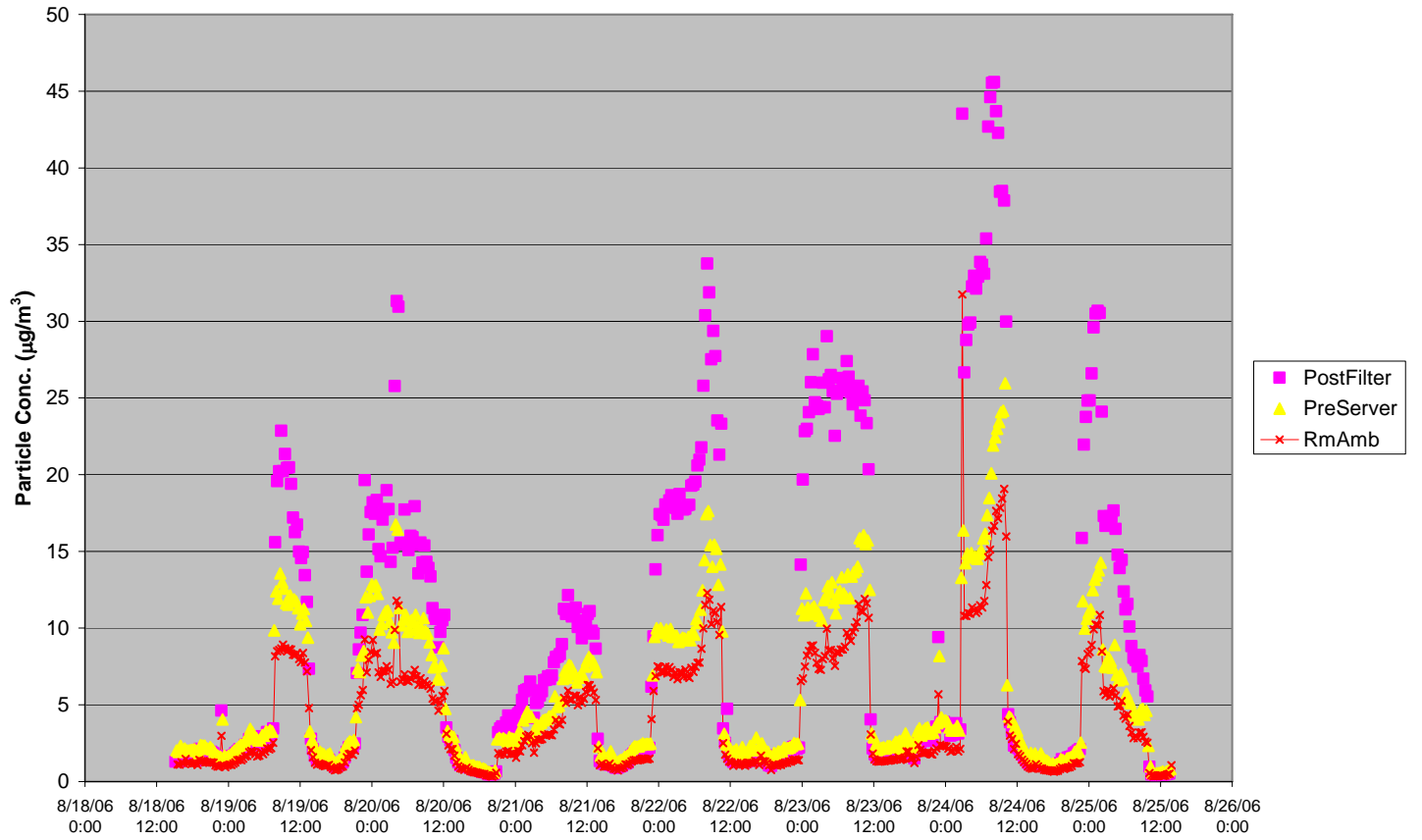

Figure 24: Center 8 indoor particle concentration



## Discussion

Particle measurements were taken to document particle concentrations in data centers and compare these measurements to industry defined concentration limits. The concentration limits vary considerably for the industry standards identified. The IBM particle concentration limit, for example, is  $150 \mu\text{g}/\text{m}^3$  for fine particles (“fine particles” typically refers to particle with diameters smaller than  $2.5 \mu\text{m}$ , but IBM’s definition includes particles smaller than  $5 \mu\text{m}$ ). The recently published ASHRAE “Design Considerations for Data and Communications Equipment Centers” sets a much lower limit and is acknowledged by ASHRAE as a conservative guideline. The ASHRAE particle concentration limits are shown in Figure 25. While the ASHRAE guidelines suggest a total particle concentration limit of  $55 \mu\text{g}/\text{m}^3$ , the fine particle concentration limit is set at  $15 \mu\text{g}/\text{m}^3$ . Indoor particle measurements from this study primarily consisted of particles in the fine particle range, so comparing our results to a  $15 \mu\text{g}/\text{m}^3$  annual limit would be a conservative interpretation of the ASHRAE standard.

Figure 25: ASHRAE annual average particle concentration limits for data centers

Contaminants	Concentration
Airborne Particles (TSP)	$20 \mu\text{g}/\text{m}^3$
Coarse Particles	$<10 \mu\text{g}/\text{m}^3$
Fine Particles	$15 \mu\text{g}/\text{m}^3$
Water Soluble Salts	$10 \mu\text{g}/\text{m}^3$ max-total
Sulfate	$10 \mu\text{g}/\text{m}^3$
Nitrites	$5 \mu\text{g}/\text{m}^3$
Total	$55 \mu\text{g}/\text{m}^3$

### Particle Measurements

All outdoor measurements taken at the data centers exceeded the ASHRAE limits, except for the summer measurements in Dublin. The average particle concentration at all of the centers is approximately  $20 \mu\text{g}/\text{m}^3$ . As a point of reference for that level of air quality, the EPA 24-hour and annual fine particle limits are  $35 \mu\text{g}/\text{m}^3$  and  $15 \mu\text{g}/\text{m}^3$  respectively. The indoor concentration measured at data centers not using economizers was, as expected, significantly lower. No data center without economizers measured a particle concentration above  $5 \mu\text{g}/\text{m}^3$ , with most of the measurements below  $1 \mu\text{g}/\text{m}^3$ . For the most part, there was minimal correlation between indoor concentrations and the outside air, though drastic changes in outdoor concentrations did appear to influence the indoor concentration (note the July 4<sup>th</sup> concentration spike at Center 7).

A distinct increase in particle concentration occurred when economizers were used, though these increases were still lower than ASHRAE standards. When



economizer vents were open particle concentrations were measured within the range of the 15  $\mu\text{g}/\text{m}^3$  ASHRAE limit. Concentrations at Center 7 and 8 were often in the range of 10-20  $\mu\text{g}/\text{m}^3$ . However, particle concentration quickly dropped back to pre-economizer levels when the vents closed. Since economizers only allow outside air part of the time, the annual average concentration would still comply with the ASHRAE standard.

### *Humidity Measurements*

Humidity was also measured at many of the data centers in this study. ASHRAE provides a “recommended” humidity range between 40-55% and an “allowable” humidity range between 20-80%. Humidity measurements at data centers not using economizers were all very steady and fell within the ASHRAE recommended range, except for Center 2, which dropped slightly below 40% during the last day of measurements (Figure 26). Figure 27 shows the humidity in Center 8 became slightly less steady when the economizers were activated. Small spikes in humidity can also be seen that correlate to when the economizer dampers were in the process of opening or closing. While the humidity spikes could be a cause for concern, the peaks of the spikes are still within the ASHRAE acceptable humidity limits. The humidity measurements taken at Center 7 after economizers were installed is also less steady, but more importantly the humidity is consistently below the ASHRAE recommended humidity level, and briefly drops below the ASHRAE allowable humidity level. The low humidity seen in Center 7 is most probably due to the position of the air ducts, which can cause the cool outside air to enter the zone and mix with warm air that has already passed across the servers. It is important to note that the humidity measurements at Center 7 were taken shortly after the economizers were installed and the data center managers were still in the process of calibrating the appropriate damper set points.

Figure 26: Humidity at server rack for four data centers without economizers

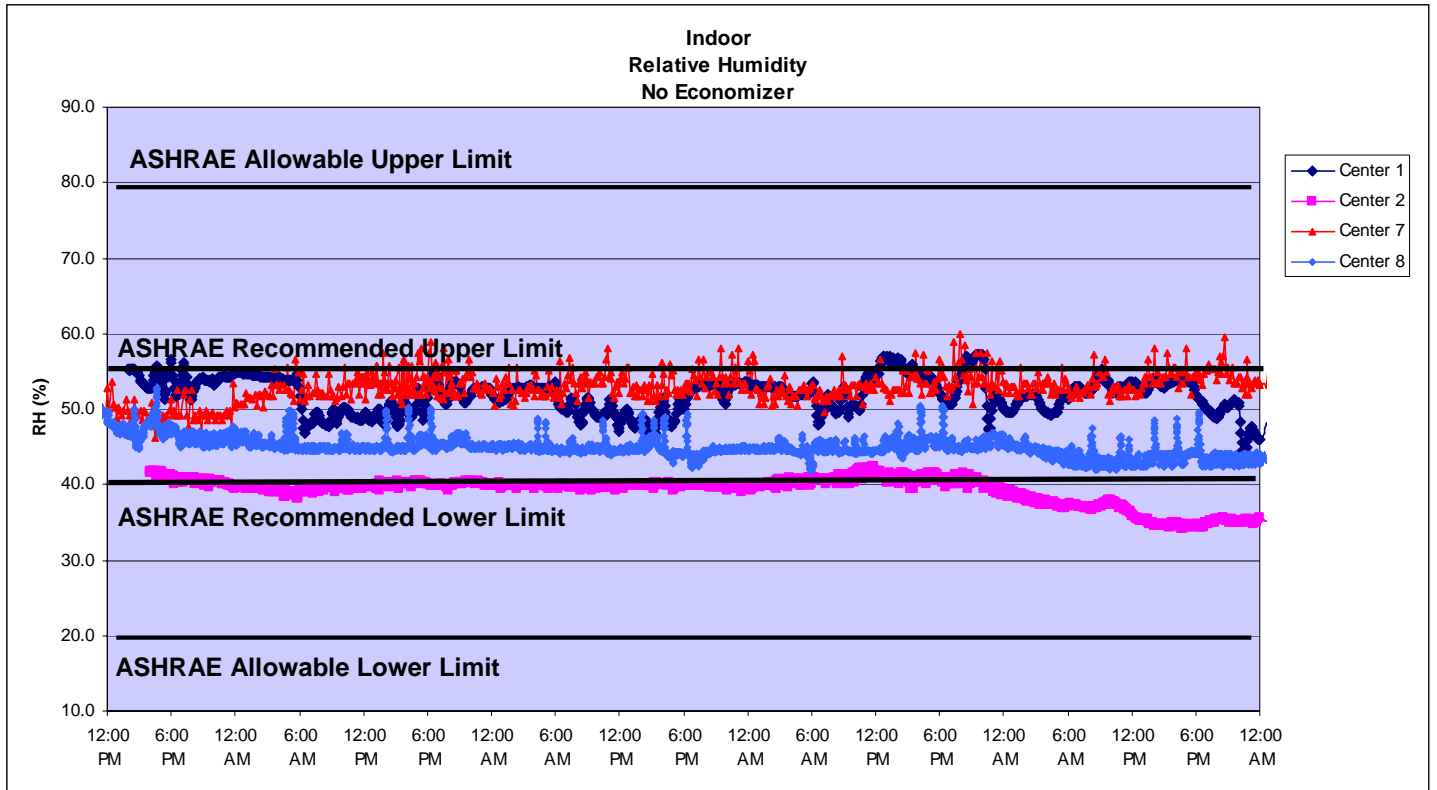
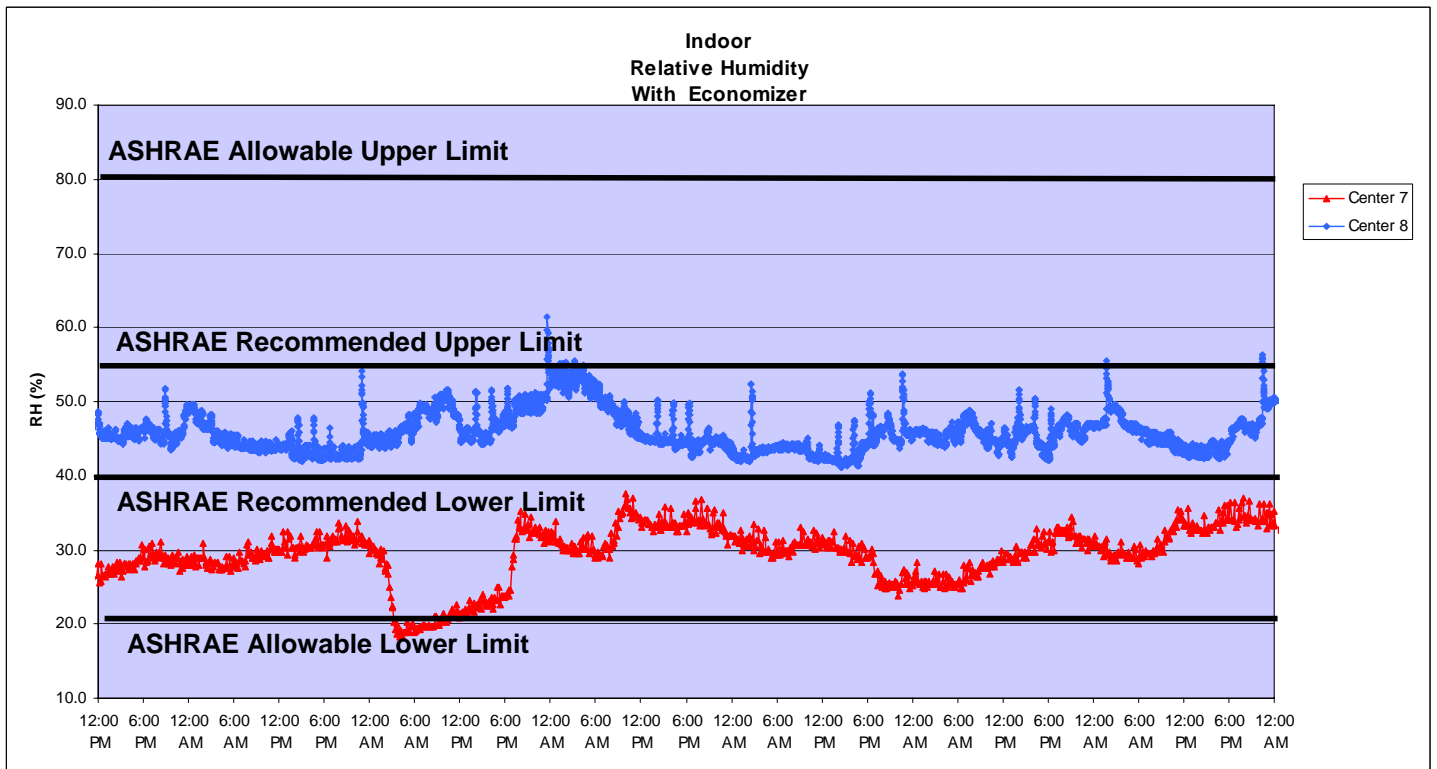

Figure 27: Humidity at server rack for data centers with economizers



### Improved Filtration

While particle concentrations measured in the data centers using economizers meet ASHRAE's conservative particle standard, the relative increase in particle concentration seen with economizer use may concern some data center managers. Improved filtration could allay these concerns by further reducing the particle concentration in data centers using economizers. ASHRAE recommends modest Class II, 40% level, filters (equivalent to a MERV 9 filter rating) in data centers that use minimal outside air. This type of filtration was observed in the CRAC units and outside air handlers at all the data centers monitored in this study. Filtration was not changed when data centers 7 and 8 shifted to economizer use. ASHRAE Class II, 85% filters (equivalent to a MERV 11 filter rating) are another commonly used filter with a higher filtration performance. Figure 28 shows the average particle concentration, separated by particle size, in Center 8 after economizer activation. Also shown is the estimated particle concentration in Center 8 if the 40% filters were replaced by 85% filters. The change in particle concentration is estimated by comparing the difference in filter efficiency between the two filter types, for each particle size range. Removal efficiency for 40% and 85% ASHRAE filters have been previously calculated for the particle sizes measured in this study (Hanley et al., 1994, Riley et al., 2002). The estimate shows that such a shift in filter performance drops the average concentration in Center 8 from  $6.5 \mu\text{g}/\text{m}^3$  to  $1.4 \mu\text{g}/\text{m}^3$ , which is in the concentration range measured at some of the data centers that do not use economizers.

Figure 28: Comparison of 40% filters (empirical) and 85% filters (estimated)

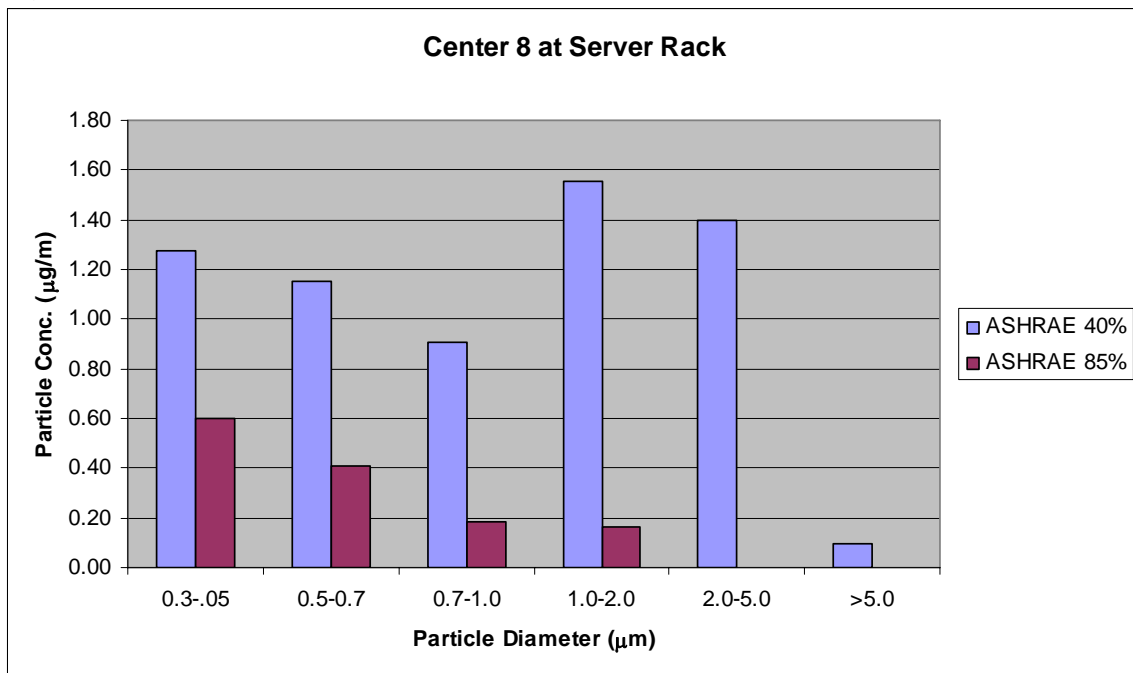

### *Energy Savings Potential*

Power demand in Center 8 was analyzed to estimate the potential energy savings gained when using economizers. The temperature set point in Center 8 was adjusted to bring in outside air whenever the outdoor temperature dropped below 62 degrees Fahrenheit. During the particle monitoring period this typically occurred during the late evening and early morning hours. The economizers reduced the load on the chiller, but there was also a slight increase in power used by the air handlers as the exhaust fan ramped up to maintain static pressure in the data center. The main power switch board at Center 8 showed a 20-30 kW power drop in the 6700 ft<sup>2</sup> data center when the economizer vents opened. According to weather data, the outdoor temperature is below 62 degrees during 68% of the year (DOE, 2006). This correlates to an energy savings of 119-173 MWh/year. If the temperature set point is raised to 68 degrees, the ASHRAE recommended temperature limit, the savings increase to 136-234 MWh/year. However, it was also noted the latent heat of vaporization affected the energy savings. An increase in chiller load was observed when the outside humidity was higher than 70%, as energy was used to remove the moisture from the air to maintain the ASHRAE 40-60% humidity range in the data center. If an outdoor humidity constraint of 70% is included, the energy savings for a 62 and 68 degree set-point drop to 35-53 MWh/year and 55-83 MWh/year respectively. Greater savings may be available if higher humidity levels in the data center area were permitted.

### **Conclusion**

Data centers currently operate under very low contamination levels. Economizers can be expected to increase the particle concentration in data centers, but the increase appears to still be below the most conservative particle standards. The particle concentration increase caused by economizer use can also be negated with modest improvements in air filtration. Humidity was consistent and within the ASHRAE recommended levels for all the data centers without economizers. Results from Center 8 show that, while slightly less uniform, data centers with economizers can also control humidity within the ASHRAE recommended levels. The potential energy savings from economizer use is considerable. Annual savings at Center 8 are estimated within the range of 55-83 MWh/year. Greater savings may be available if higher humidity levels in the data center area were permitted. The results from this study indicate that IT equipment reliability degradation due to outdoor contamination appears to be a poor justification for not using economizers in data centers.

## Recommendations for Future Work

The intent of the current demonstration is to provide insight into how outside air can be used for cooling without compromising server equipment reliability with ultimate goal of reducing the operational energy of data centers. This preliminary work will help determine how outside air pollutants can cause equipment damage and determine when economizer use would expose equipment to critical pollutant concentration levels. Below is a description of future research tasks that would complement this initial data center research.

1. Identify methods of failure and estimate failure probability:

Perform literature search on sources of potential server failure caused by introduction of outside air. In collaboration with server manufacturers and the ASHRAE data center committee, provide an overview of the types of failures that can occur, such as current leakage or heat trapping. Identify the causes of the failure, beyond hygroscopic particles, and explain the believed mechanism by which these failures occur. Outdoor pollutant characteristics may vary by location within California. Review how the size and chemical composition influences equipment problems. Address the contribution of deposited fibers, which may enhance circuit failure rates by contributing to current bridging between isolated conductors. Literature search will also include identifying and possibly developing potential methods to estimate the probability of failure under given pollutant conditions. For example, the applicability of percolation theory will be reviewed. Percolation theory may be used to correlate the probability of particle bridging with the volume of particles deposited in a given space.

2. Review experimental evidence of failure:

The literature review of aerosol particle dynamics would then be complimented by a review of experimental data. Previous experiments under controlled condition will be reviewed to determine how well observations match theoretical information. Experimental evidence will also be used to determine information such as the magnitude of current leakage, deposition locations, and failure points within servers.

3. Gather empirical data on outdoor/indoor concentration and server failures:

Measure particle concentration and composition at (approximately 6) currently operating data centers under different seasonal conditions than the previous work. Seasonal conditions will affect outdoor pollution levels and HVAC operation. Measurement will be taken for both indoor and outdoor particle concentrations. Concentration ratios for data center with and without economizers will be compared under different seasonal conditions. Contacts developed at these data centers, as well as other industry contacts from previous projects will be used to collect information on server failure rates and the recorded cause of failure in certain operating data centers.

#### 4. Cost/benefit analysis:

##### *Individual data center operation*

Determine the potential environmental and cost savings gained from economizer use in different climate and pollutant conditions found in California. Determine how cost and benefit are affected by the use of different mitigation and detection technologies.

##### *Statewide energy savings*

Review literature to estimate current square footage of data centers in California. Estimate data center distribution throughout the State to weight individual data center savings and estimate total potential saving under various design scenarios.

##### *System benefits*

Estimate system benefits from the reduced statewide energy demand. This portion of the task may involve working with outside organizations, such as the Rocky Mountain Institute.

#### 5. Overcoming implementation barriers:

##### *Responsive architecture*

Review precautionary systems that could be used to warn data center operators of critically high pollutant concentrations. Potential devices include VESDAs (Very Early Smoke Detection Apparatus), which are currently used in many data centers as an early detection fire alarm. Another option is the use of a coupon, which is an apparatus designed to be affected by particle bridging at a faster rate than server equipment, thus able to act as a harbinger to obviate equipment problems.

##### *Issues of concern*

Identify other reservations that data center operators may have in using air side economizers. Use contacts developed in 3 to interview operators and determine what type of precautionary measures would adequately address their concerns.

## References

ASHRAE Design Considerations for Data and Communications Equipment Centers, 2005, American Society of Heating, Refrigerating, and Air-conditioning Engineers, Inc., Atlanta, GA

ASHRAE Thermal Guidelines for Data Processing Environments, 2004, ASHRAE, Atlanta, GA.

Department of Energy (DOE), Energy Efficiency and Renewable Energy; EnergyPlus Simulation Software;  
<http://www.eere.energy.gov/buildings/energyplus/weatherdata>

Hanley, J. T.; Ensor, D. S.; Smith, D. D.; Sparks, L. E. 1994, Indoor Air, 4, 169-178.

Litvak, A., Gadgil, A. J., 2000, "Hygroscopic fine mode particle deposition on electronic circuits and resulting Degradation of Circuit Performance: An Experimental Study." Indoor Air. Vol. 10, pp 47-56.

Riley, W.J., McKone, T.E., Lai, A.C.K., Nazaroff, W.W., 2002. "Indoor particulate matter of outdoor origin: importance of size-dependent removal mechanisms." Environmental Science and Technology 36, 200–207.

Telcordia, 2002. GR-63-CORE, Network equipment – Building Systems (NEBS) requirements: Telcordia Technologies Generic Requirements, Issue 2, April 2002. Piscataway, N.J.: Telcordia Technologies, Inc.

Weschler, C.J. and Shields, H.C. 1991 "The impact of ventilation and indoor air quality on electronic equipment", ASHRAE Transactions, 97, 455-463.